

Accesorios para mamparas divisorias



ACCESSORI PER PARETI DIVISORIE

ACCESSORIES FOR CUBICLES AND PARTITIONS

I COMPONENTI DEL PROGRAMMA 500 SONO STATI PROGETTATI PER REALIZZARE CABINE E PARTIZIONI PER LA DIVISIONE DEGLI SPAZI. THE COMPONENTS IN THE 500 PROGRAM HAVE BEEN DESIGNED FOR THE CREATION OF PANELLED BOOTHS AND PARTITIONS FOR DIVIDING OPEN SPACES.



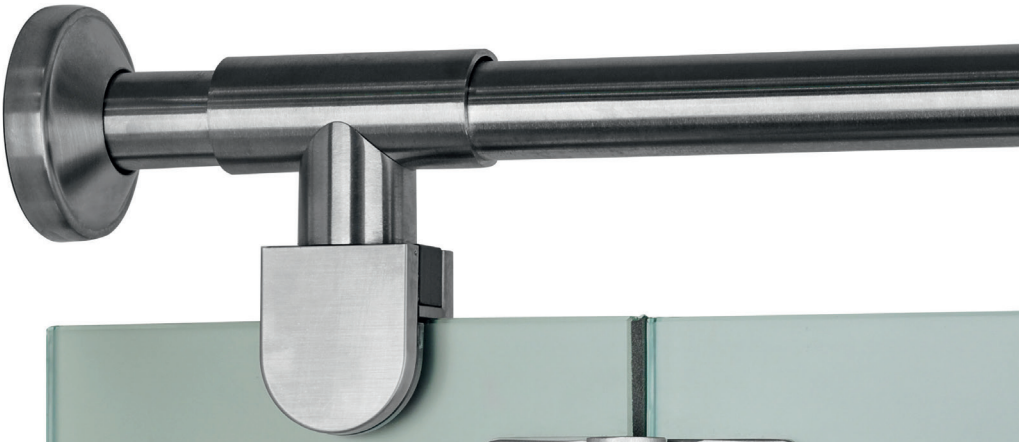

PROGRAMMA 500-SS

Stainless steel AISI 316L

page 226



PROGRAMMA 500-GSS

Stainless steel AISI 316L

page 234

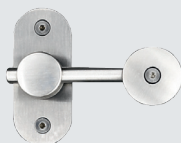

PROGRAMMA 500-CM

Nylon
Stainless steel AISI 316L

page 242



PROGRAMMA 500-NY
Nylon

page 252



PROGRAMMA 500-ALU
Aluminium

page 262

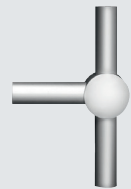

LEGEND
page 1

TECHNICAL REFERENCES
page 298

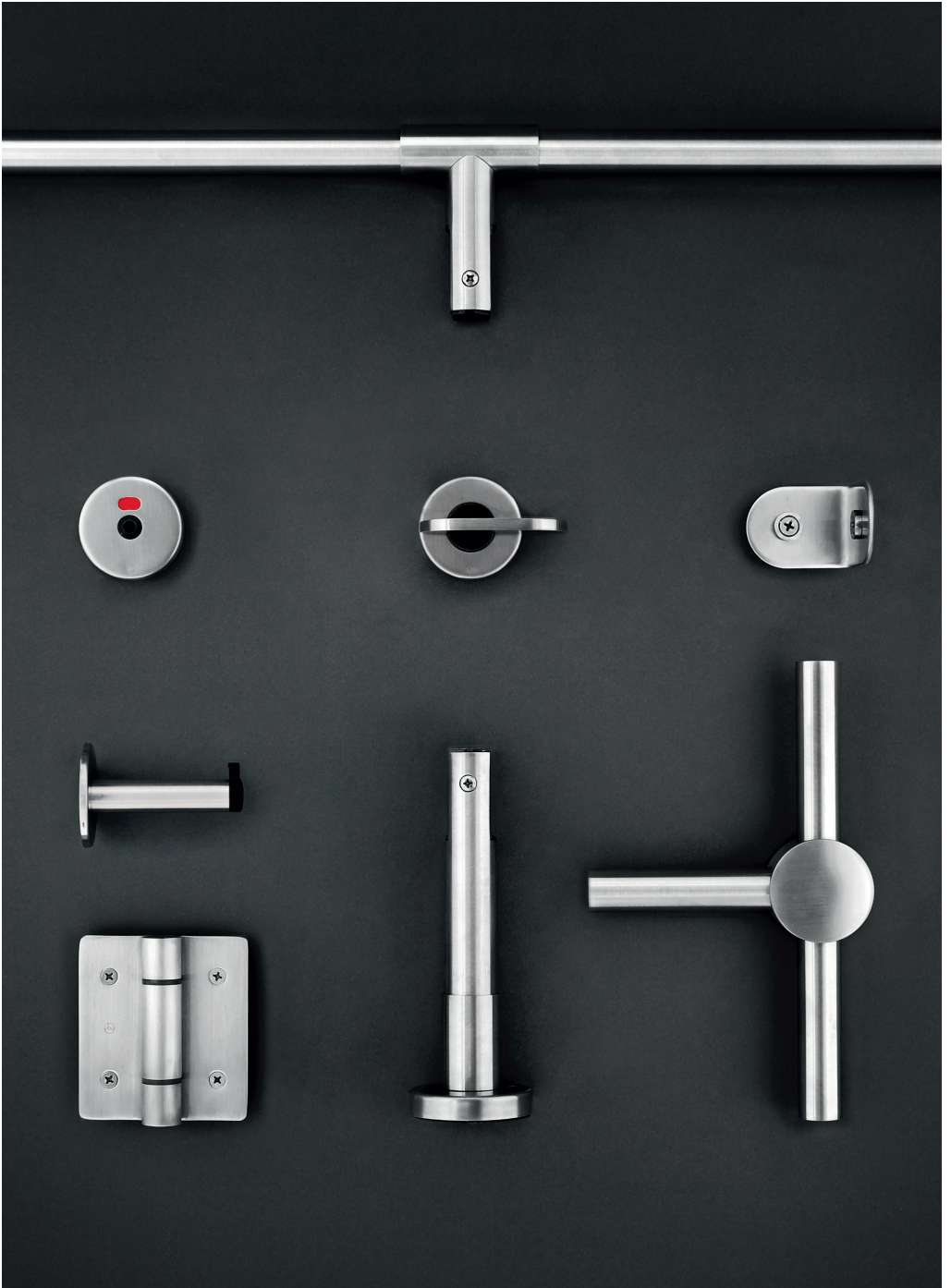

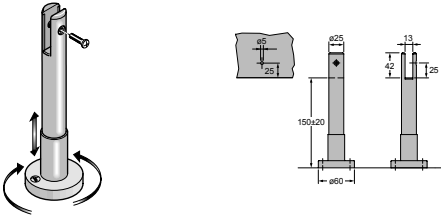

ART.

5CS.550.0000.44

- Piedino (150mm) registrabile (± 20 mm) con pinza per pannello di spessore 13mm
- 150mm Adjustable foot (± 20 mm) with clamp for panels, 13mm thickness
- Pied (150mm) réglable (± 20 mm) avec pince pour panneaux au épaisseur 13mm
- Regulierbarer Fuss (130-170mm) für Laminatpaneele Stärke 13mm
- Pie regulable (130-170mm) para paneles de laminado 13mm de espesor
- Regelbare voet (130-170mm) voor compact paneel dikte 13mm

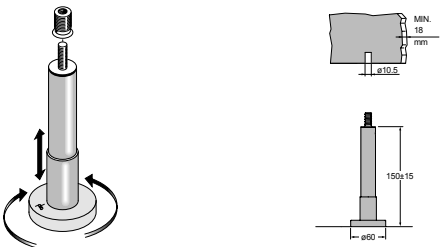

ART.

5CS.550.000U.44

- Piedino (150mm) registrabile (± 15 mm) per pannello di spessore minimo 18mm
- 150mm Adjustable foot (± 15 mm) for panels, 18mm thickness min
- Pied (150mm) réglable (± 15 mm) pour panneau épaisseur 18mm min
- Regulierbarer Fuss (135-165mm) für Laminatpaneele mit Befestigungsbuchse (min. Durchmesser 18mm)
- Pie regulable (135-165mm) para paneles de laminado con casquillo de fijación inferior (espesor mínimo 18mm)
- Regelbare voet (135-165mm) voor paneel met koppelingsring (dikte 18mm min)

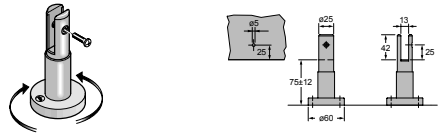

ART.

5CS.550.000T.44

- Piedino ribassato (75mm) registrabile (± 12 mm) con pinza per pannello di spessore 13mm
- 75mm Adjustable lowered foot (± 12 mm) with clamp for panels, 13mm thickness
- Pied surbaissé (75mm) réglable (± 12 mm) avec pince pour panneaux 13mm
- Regulierbarer Fuss (63-87mm) für Paneele 13mm
- Pie regulable rebajado (63-87mm) para paneles 13mm
- Lage regelbare voet (63-87mm) voor paneel 13mm

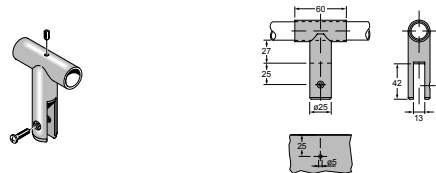

ART.

5CG.551.0000.44

- Pinza superiore per pannello di spessore 13mm, con innesto tubo in linea
- Inline top panel holder for panels, 13mm thickness
- Pince supérieure pour panneau d'épaisseur 13mm, avec raccord tube en ligne
- Oberer Halter zur Befestigung Paneele 13mm
- Pinza superior para fijación de panel 13mm
- Boven paneel 13mm bevestigingskiem

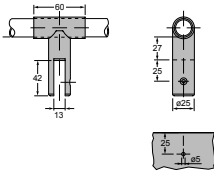

ART.

5CS.551.000B.44

- Pinza superiore per pannello di spessore 13mm, con innesto tubo perpendicolare
- Top panel holder, 90° for panels 13mm thickness
- Pince supérieure pour panneau épaisseur 13mm avec raccord tube perpendiculaire
- Oberer Halter zur Befestigung, Panele 13mm; Rohreinsatz 90° versetzt
- Pinza superior para fijación de panel 13mm con racor para tubo perpendicular
- Boven paneelklem (13mm) met loodrechte buisverbinding

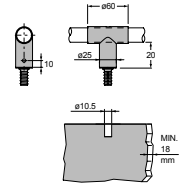
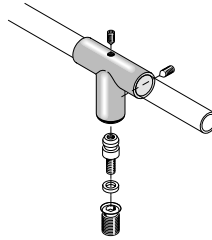

ART.

5CS.551.000U.44

- Pinza superiore per pannello di spessore minimo 18mm
- Top panel holder, for panels 18mm thickness min
- Pince supérieure pour panneau d'épaisseur 18mm min
- Obere Stütze zur Befestigung Panele mit oberer Buchse (min. Durchmesser 18mm)
- Soporte superior para fijación de panel con casquillo superior (espesor mínimo 18mm)
- Bovensteun voor paneelbevestiging met koppeling (dikte 18mm min.)

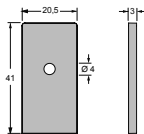
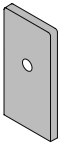

ART.

5CS.550.0010.44

- Spessore sagomato per piedino e pinza
- Shaped shim for foot and panel holder
- Cale de forme pour pied et pince
- Geförmte Dichtung für Fuss und Scharnier
- Espaciador conformado para pie y pinza
- Verdikkingsplaatje op maat voor voet en paneelhauder

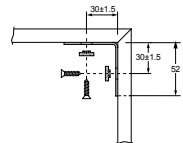
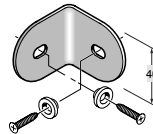

ART.

5CS.552.0000.00

- Angolare per fissaggio
- Angle bracket to fix panels
- Equerre de fixation
- Winkel zur Befestigung Panele
- Escuadra para fijación de paneles
- Paneel bevestigingshaak

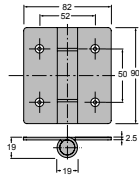
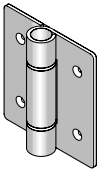

ART.

5CS.553.000N.44

- Cerniera complanare
- Coplanar hinge
- Charnière Applique
- Gleitscharnier für Panele
- Bisagra normal para paneles
- Scharnier voor paneel deur

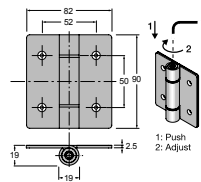
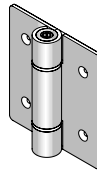

ART.

5CS.554.00CN.44

- Cerniera complanare autochudente
- Self-closing coplanar hinge
- Charnière Applique de fermeture automatique
- Gleitscharnier selbstschließend für Panele
- Bisagra con resorte para paneles
- Scharnier voor automatisch sluitende paneel deur

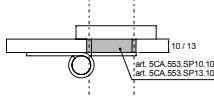
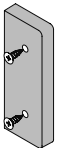

ART.

5CA.553.SP10.10 (10 mm)
5CA.553.SP13.10 (13 mm)

- Spessore sagomato per cerniere
- Shaped shim for hinges
- Cale de forme pour charnière
- Geformte Dichtung für Scharnier
- Espaciador conformado para bisagras
- Verdikkingsplaatje op maat voor scharnieren

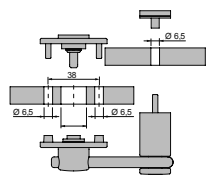
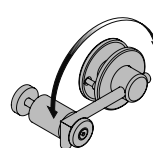

ART.

5CS.558.000C.44

- Chiusino libero/occupato con chiusura su fermo per porta a scorrere
- Occupancy indicator for sliding doors
- Dispositif de fermeture libre/occupé avec tige de fermeture sur gache pour porte coulissante
- Frei-Besetzt Garnitur mit feststehender Verriegelung für schiebe Tür
- Muletilla con indicador libre/ocupado para puertas correderas
- Vrij/bezet eenheid met grendel op sluitplaat

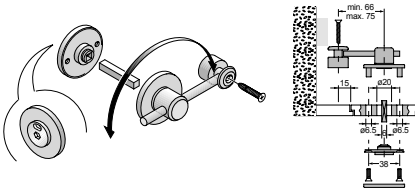

ART.

5CS.558.0000.44

- Chiusino libero/occupato con chiusura su fermo
- Snib with vacant/engaged indicator and spindle
- Dispositif de fermeture libre/occupé avec tige de fermeture sur gache
- Frei-Besetzt Garnitur mit feststehender Verriegelung
- Muletilla libre/ocupado con varilla de cierre sobre tope
- Vrij/bezet eenheid met grendel op sluitplaat

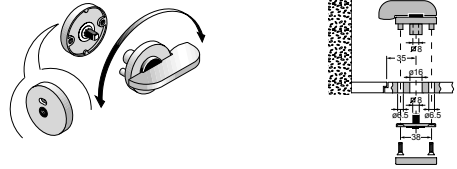

ART.

5CS.558.00LE.44

- Chiusino libero/occupato con leva in acciaio
- Snib with vacant/engaged indicator with steel lever
- Dispositif de fermeture libre/occupé avec levier en acier
- Frei-Besetzt Garnitur mit Griff in Stahl
- Muletilla libre/ocupado con manilla de cierre para puerta de acero
- Vrij/bezet eenheid met grendel voor stalen deur

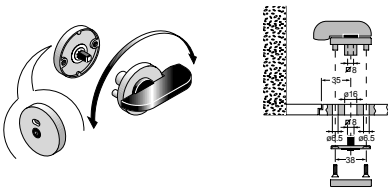

ART.

5CS.558.0LEE.44

- Chiusino libero/occupato con leva in alluminio
- Snib with vacant/engaged indicator with aluminium lever
- Dispositif de fermeture libre/occupé avec levier en aluminium
- Frei-Besetzt Garnitur mit Griff in Aluminium
- Muletilla libre/ocupado con manilla de cierre para puerta de aluminio
- Vrij/bezet eenheid met grendel voor aluminium deur

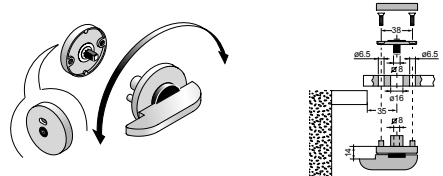

ART.

5CS.558.0LER.44

- Chiusino libero/occupato con leva in acciaio per pannello a sormonto spessore 13 mm
- Occupancy indicator with steel lever for 13mm overlapping panels
- Dispositif de fermeture libre/occupé avec levier en acier pour panneau à recouvrement épaisseur 13 mm
- Frei-Besetzt Garnitur mit Griff in Stahl für aufschlagendes Paneel mit Stärke 13mm.
- Muletilla con indicador libre/ocupado de acero para paneles superpuestos de 13mm
- Vrij/bezet eenheid met grendel voor stalen deur

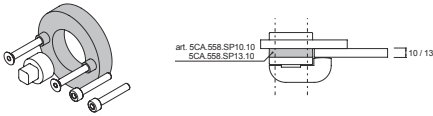

ART.

5CA.558.SP10.10 (10 mm)
5CA.558.SP13.10 (13 mm)

- Spessore sagomato per chiusini (5CS.558.00LE.44, 5CS.558.0LEE.44)
- Shaped shim for snib indicators (5CS.558.00LE.44, 5CS.558.0LEE.44)
- Cale de forme pour verrou (5CS.558.00LE.44, 5CS.558.0LEE.44)
- Geformte Dichtung für Verriegelung (5CS.558.00LE.44, 5CS.558.0LEE.44)
- Espaciador conformado para muletillas (5CS.558.00LE.44, 5CS.558.0LEE.44)
- Verdikkingsplaatje op maat voor WC vergrendeling (5CS.558.00LE.44, 5CS.558.0LEE.44)

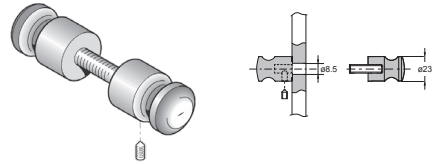

ART.

5CS.564.000D.44

- Pomolo doppio e fisso
- Double fixed knob
- Bouton double et fixe
- Doppelter Türknopf für Panele
- Doble pomo para panel
- Dubbele knop voor paneel

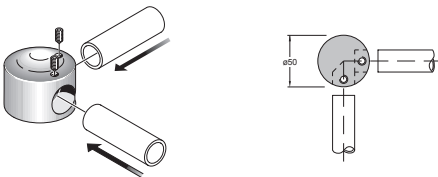

ART.

5CS.556.0000.44

- Giunto a 90° a 2 vie, per unione art.5CS.560.0000
- 90° degree top joint, two way, to suit art.5CS.560.0000
- Raccord 90° 2 voies pour jonction art.5CS.560.0000
- Verbindungselement 22mm - Rohr 22mm 2 seitig 90°
- Codo 90° - tubo 22mm
- Verbinding 22mm - buis 22mm 2 richtingen 90°

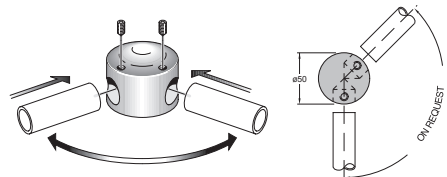

ART.

5CS.557.0000.44

- Giunto, con angolo a richiesta, a 2 vie, per unione art.5CS.560.0000
- Universal top joint, two way, to suit art.5CS.560.0000, please state angle required
- Raccord, avec angle sur demande, 2 voies pour jonction art.5CS.560.0000
- Verbindungselement 22mm - Rohr 22mm 2 seitig, Winkel auf Anfrage
- Codo especial angulo a medida - tubo 22mm
- Verbinding 22mm - buis 22mm 2 richtingen - hoek volgens opgave

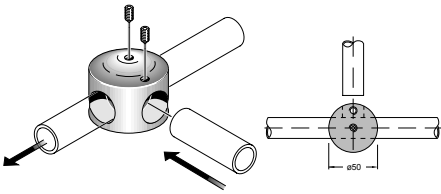

ART.

5CS.561.0000.44

- Giunto a 3 vie per unione art.5CS.560.0000
- Top T-joint, three way, to suit art.5CS.560.0000
- Raccord 3 voies pour jonction art.5CS.560.0000
- Verbindungselement 22mm - Rohr 22mm 3 seitig
- Unión en T - tubo 22mm
- Verbindingsstuk 3 wegs voor buis 22mm

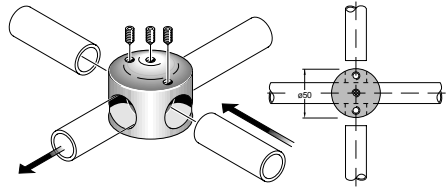

ART.

5CS.561.000B.44

- Giunto a 4 vie per unione art.5CS.560.0000
- Top X-joint, four way, to suit art.5CS.560.0000
- Raccord 4 voies pour jonction art.5CS.560.0000
- Verbindungselement 22mm - Rohr 22mm 4 seitig
- Unión en X cruce para tubo 22mm
- Verbindingsstuk 4 wegs voor buis 22mm

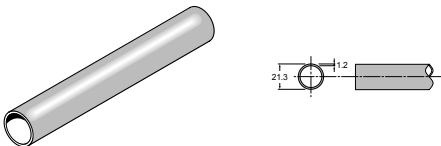

ART.

5CS.560.0000.44

- Tubo superiore in barre da 3 metri
- Top rail tube, 3 metres long
- Tube supérieur en barre de 3 mètres
- Oberes Stützrohr 21,3 mm, 3 Meter
- Tubo superior de soporte, diámetro 21,3 mm, 3 metros
- Steunbuis boven 21,3 mm, lengte 3 meter

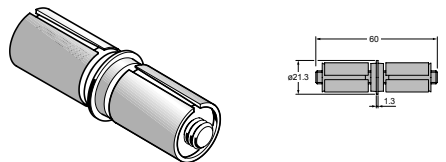

ART.

5CS.563.0000.44

- Giunzione per unione art.5CS.560.0000 con art.5CS.560.0000
- Tube connector, expanding plug to suit art.5CS.560.0000 connection
- Raccord pour jonction art.5CS.560.0000 avec art.5CS.560.0000
- Expansions - Verbindungselement Rohr 22mm - Rohr 22mm
- Unión para tubo 22mm - tubo 22mm de expansión
- Rechte verbinding voor buis 22mm uitbreiding

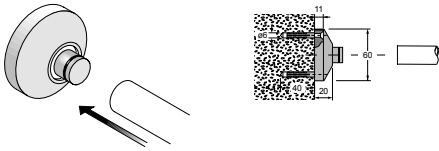

ART.

5CS.555.0000.44

- Rosetta per fissaggio art.5CS.560.0000 a parete
- Tube-wall fixing rose suitable for art.5CS.560.0000
- Rosace pour fixation art.5CS.560.0000 à paroi
- Befestigungsrosette Rohr 21,3 mm auf Mauer
- Roseta de fijación de tubo 21,3 mm en pared
- Rozet voor muurbevestiging voor buis 21,3 mm

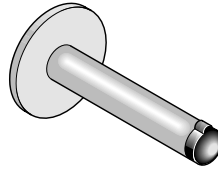

ART.

5CS.562.0000.44

- Appendiabiti/fermaporta
- Door-stop and clothes hook
- Butoir portemanteau
- Türstopper Kleiderhaken
- Tope de puerta colgador
- Deurstop-kledinghanger

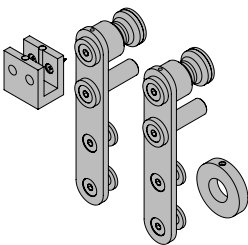

ART.

5CS.570.0000.44

- Kit di montaggio per porte a scorrere
- Fixing kit for sliding doors
- Kit de montage pour portes coulissantes
- Montageset für Schiebetüren
- Juego de fijación para puertas correderas
- Schuifdeursysteem kit

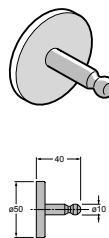

ART.

4CS.488.0000.44

- Appendiabiti
- Cloth hook
- Portemanteau
- Kleiderhaken einfach
- Colgador sencillo
- Kleerhanger enkel

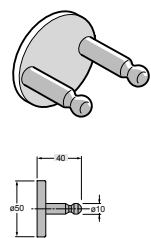

ART.

4CS.488.0000D.44

- Appendiabiti
- Cloth hook
- Portemanteau
- Kleiderhaken einfach
- Colgador sencillo
- Kleerhanger enkel



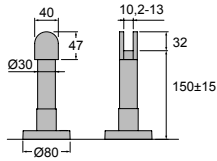
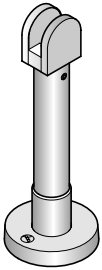

ART.

5CG.550.0000.44

- Piedino (150mm) registrabile (± 15 mm) con pinza per vetro di spessore variabile da 10,2 a 13mm
- 150mm Adjustable foot (± 15 mm) with glass clamp (10,2-13mm)
- Pied (150mm) réglable (± 15 mm) avec pince de fixation verre réglable de 10,2mm à 13mm
- Regulierbarer Fuss (135-165mm) mit Glashalter (10,2-13mm)
- Pie regulable (135-165mm) con pinza de fijación para cristal (10,2-13mm)
- Regelbare voet (135-165mm) met glasklem (10,2-13mm)

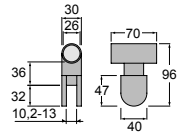
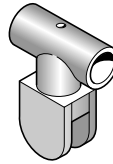

ART.

5CG.551.0000.44

- Pinza superiore per vetro di spessore 10,2-13mm, con innesto tubo in linea
- Tubular top glass clamp, inline (10,2-13mm)
- Pince supérieure de fixation verre (10,2-13mm) avec raccord tube en ligne
- Oberer Glashalter (10,2-13mm)
- Pinza superior para fijación de cristal (10,2-13mm)
- Bovenklem voor glas (10,2-13mm)

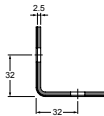
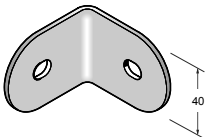

ART.

5CG.552.0000.44

- Angolare per fissaggio
- Angle bracket for fitting to glass
- Equerre de fixation verre
- Winkel zur Glasbefestigung
- Escuadra para fijación a cristal
- Glas bevestigingshaak

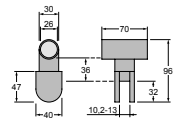
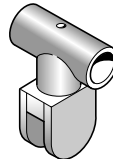

ART.

5CG.551.000B.44

- Pinza superiore per vetro di spessore 10,2-13mm, con innesto tubo perpendicolare
- Tubular top glass clamp, 90° degrees (10,2-13mm)
- Pince supérieure de fixation verre (10,2-13mm) avec raccord tube perpendiculaire
- Oberer Glashalter (10,2-13 mm); Rohreinsatz 90° versetzt
- Pinza superior para fijación de cristal (10,2-13mm) con racor para tubo perpendicular
- Bovenklem voor glas (10,2-13mm) met loodrechte buisverbinding

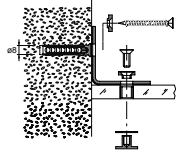

ART.

5CG.552.000A.44

- Set per fissaggio vetro-parete con art.5CG.552.0000
- Fitting kit for fixing angle bracket from glass to wall
- Jeu de fixation mur-verre pour art.5CG.552.0000
- Befestigungsset Mauer-Glas Eckausführung in Edelstahl 1.4404
- Juego de fijación pared-cristal para escuadra
- Bevestigingsset muur-glas voor haak

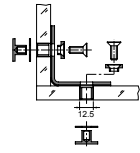

ART.

5CG.552.000B.44

- Set per fissaggio vetro-vetro con art.5CG.552.0000
- Fitting kit for fixing angle bracket from glass to glass
- Jeu de fixation verre-verre pour art.5CG.552.0000
- Befestigungsset Glas-Glas Eckausführung in Edelstahl 1.4404
- Juego de fijación cristal-cristal para escuadra
- Bevestigingsset glas-glas voor haak

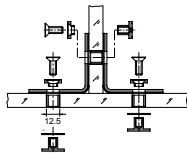

ART.

5CG.552.000C.44

- Set per fissaggio vetro-vetro con art.5CG.552.0000
- Fitting kit for fixing angle bracket from glass to glass
- Jeu de fixation verre-verre pour art.5CG.552.0000
- Befestigungsset Glas-Glas Eckausführung in Edelstahl 1.4404
- Juego de fijación cristal-cristal para escuadra
- Bevestigingsset glas-glas voor haak

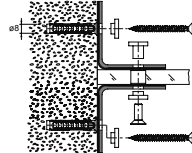

ART.

5CG.552.000D.44

- Kit di fissaggio vetro-parete con squadretta doppia
- Glass to wall fixing kit for double angle bracket
- Jeu de fixation mur-verre pour art.5CG.552.0000
- Befestigungsset Glas-Wand für Doppelwinkel
- Juego de fijación para pared-cristal con escuadra
- Bevestigingsset muur-glas voor haak

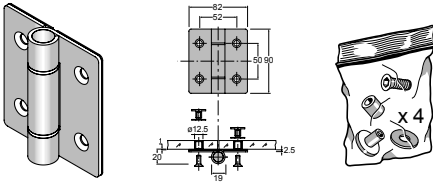

ART.

5CG.553.000N.44

- Cerniera complanare con kit di fissaggio
- Coplanar hinge for glass doors - Fitting kit included
- Charnière Applique - Jeu de fixation pour verre
- Gleitscharnier für Glastüren - Gleitscharnier mit Befestigungsset
- Bisagra para puertas de cristal - Juego de fijación incluido
- Scharnier voor glazen deur - Bevestigingsset voor in AISI 316L haak op glas te bevestigen

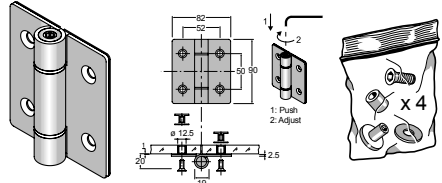

ART.

5CG.554.00CN.44

- Cerniera complanare autochudente con kit di fissaggio
- Self-closing coplanar hinge for glass doors - Fitting kit included
- Charnière Applique de fermeture automatique - Jeu de fixation pour verre
- Gleitscharnier für Glastüren selbstschließend - mit Befestigungsset
- Bisagra con resorte para puertas de cristal - Juego de fijación incluido
- Scharnier voor automatisch sluitende glazen deur - Bevestigingsset voor in AISI 316L haak op glas te bevestigen

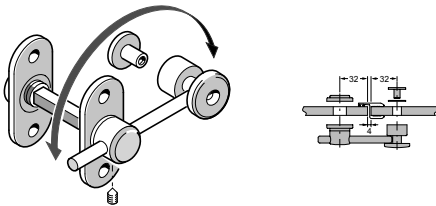

ART.

5CG.558.0000.44

- Chiusino libero/occupato
- Snib with vacant/engaged indicator
- Dispositif de fermeture libre/occupé
- Frei-Besetzt Garnitur für Glastüren
- Muletilla libre/ocupado para puertas de cristal
- Vrij/bezet eenheid voor glazen deur

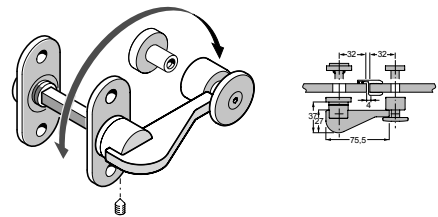

ART.

5CG.558.00LE.44

- Chiusino libero/occupato
- Snib with vacant/engaged indicator
- Dispositif de fermeture libre/occupé
- Frei-Besetzt Garnitur für Glastüren
- Muletilla libre/ocupado para puertas de cristal
- Vrij/bezet eenheid voor glazen deur

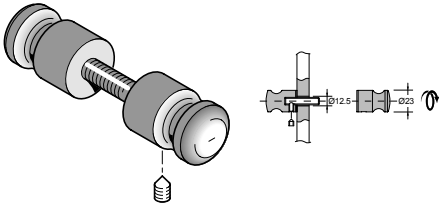

ART.

5CG.564.000D.44

- Pomolo doppio e fisso
- Double fixed knob
- Bouton double et fixe
- Doppelter Türknohfür Glastüren
- Doble pomo para puerta de cristal
- Dubbele knop voor glazen deur

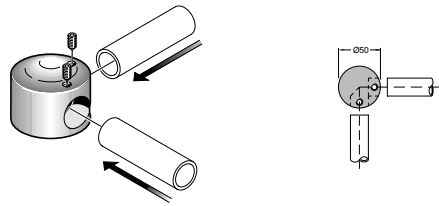

ART.

5CG.556.0000.44

- Giunto a 90° a 2 vie, per unione art.5CG.560.0000
- 90° degree top joint, two way, to suit art.5CG.560.0000
- Raccord à 90° 2 voies pour jonction art.5CG.560.0000
- Verbindungselement 25mm - Rohr 25mm 2 seitig 90°
- Codo 90° - tubo 25mm
- Verbinding 25mm - buis 25mm 2 richtingen 90°

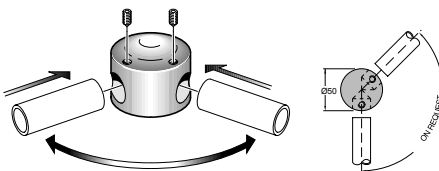

ART.

5CG.557.0000.44

- Giunto, con angolo a richiesta, a 2 vie, per unione art.5CG.560.0000
- Universal top joint, two way, to suit art.5CG.560.0000, please state angle required
- Raccord, avec angle sur demande, 2 voies pour jonction art.5CG.560.0000
- Verbindungselement 25mm - Rohr 25mm 2 seitig 90°, Winkel auf Anfrage
- Codo especial angulo a medida tubo 25mm
- Verbinding 25mm - buis 25mm 2 richtingen - hoek volgens opgave

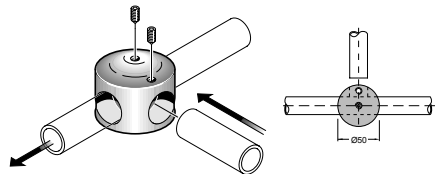

ART.

5CG.561.0000.44

- Giunto a 3 vie per unione art.5CG.560.0000
- Top T joint, three way, to suit art.5CG.560.0000
- Raccord 3 voies pour jonction art.5CG.560.0000
- Verbindungselement 25mm - Rohr 25 mm 3 seitig
- Unión en T - tubo 25mm
- Verbindingsstuk 3 wegs voor buis 25mm

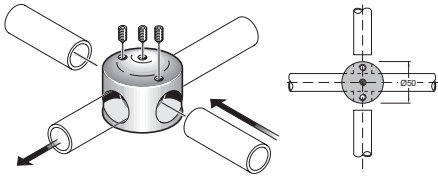

ART.

5CG.561.000B.44

- Giunto a 4 vie per unione art.5CG.560.0000
- Top X-joint, four way, to suit art.5CG.560.0000
- Raccord 4 voies pour jonction art.5CG.560.0000
- Verbindungselement 25mm - Rohr 25mm 4 seitig
- Unión en X cruce para tubo 25mm
- Verbindingsstuk 4 wegs voor buis 25mm

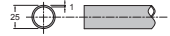
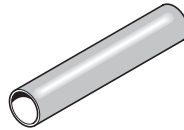

ART.

5CG.560.0000.44

- Tubo superiore in barre da 3 metri
- Top rail tube, 3 metres long
- Tube supérieur en barres de 3 mètres
- Oberes Stützrohr 25mm, 3 Meter
- Tubo superior de soporte, diámetro 25mm, 3 metros
- Steunbuis boven 25mm, lengte 3 meter

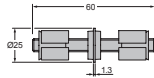
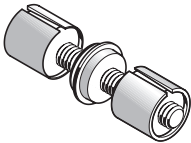

ART.

5CG.563.0000.44

- Giunzione per unione art.5CG.560.0000 con art.5CG.560.0000
- Tube connector, expanding plug to join art.5CG.560.0000 with art.5CG.560.0000
- Raccord pour jonction art.5CG.560.0000 avec art.5CG.560.0000 Expansions
- Verbindungselement Rohr 25mm - Rohr 25mm
- Unión para tubo 25mm - tubo 25mm de expansión
- Rechte verbinding voor buis 25mm

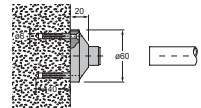
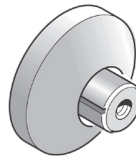

ART.

5CG.555.0000.44

- Rosetta per fissaggio art.5CG.560.0000 a parete
- Tube-wall fixing rose suitable for art.5CG.560.0000
- Rosace pour fixation art.5CG.560.0000 à paroi
- Befestigungsrosette Rohr 25mm auf Wand
- Roseta de fijación de tubo 25mm en pared
- Rozet voor muurbevestiging buis 25mm



ART.

5CG.555.000S.44

- Rosetta registrabile per fissaggio art.5CG.560.0000 a parete
- Adjustable wall fixing rose for art.5CG.560.0000
- Rosace réglable pour fixation art.5CG.560.0000 à pari
- Befestigungsrosette Rohr 25mm auf Wand regulierbar
- Roseta de fijación de tubo 25mm en pared de giro libre
- Rozet voor muurbevestiging buis 25mm regelbaar

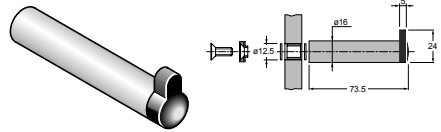

ART.

5CG.562.0000.44

- Appendiabiti/fermaporta
- Door-stop and clothes hook
- Butoir portemanteau
- Türstopper
- Tope de puerta
- Deurstop

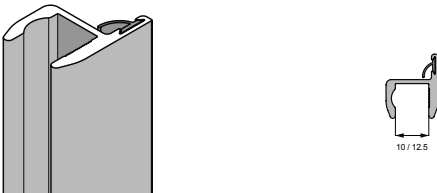

ART.

5CG.590.0010.66 (10 mm)
5CG.590.0000.66 (12,5 mm)

- Profilo di battuta in alluminio (.66 = alluminio Ossidato Inox) e guarnizione di battuta in PVC (2 m).
- Door edge, aluminium profile (.66 = aluminium Oxidized Steel) and Door Seal in PVC (2 m).
- Profil de feuillure en aluminium (.66 = aluminium Acier Oxydé) et Joint de feuillure en PVC (2 m).
- Aluminium Anschlagprofil (.66 = Aluminium Oxidierte Stahl) für Stärke 12.5mm (2 Meter). Anschlagdichtung
- Perfil de tope de aluminio (.66 = aluminio Acero Oxidado) para 12.5mm de espesor (2 metros). Guarnición de tope
- Aluminium aanslagprofiel (.66 = aluminium Geoxideerd Staal) voor 12.5mm, lengte 2 meter. Profiel dichting

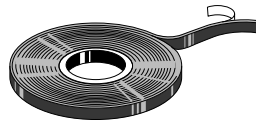

ART.

5CG.592.0000.00

- Adesivo di protezione incontro vetro-vetro
- Adhesive seal for glass edge protection
- Adhésif de protection angles butée verre-verre
- Eckschutz Glasanschlag zum kleben
- Adhesivo de protección para cantos de cristal
- Kantbescherming voor glazen deur klevend

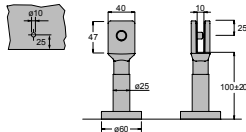
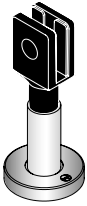

ART.

• 5CM.550.SP10.10

- Piedino (100mm) registrabile (± 20) con pinza per pannello di spessore 10mm
- 100 mm Adjustable foot (± 20 mm) with clamp for 10mm laminate panels
- Pied (100mm) réglable (± 20 mm) avec pince pour panneau épaisseur 10mm
- Regulierbarer Fuss (80mm-120mm) für Laminatpaneel 10mm
- Pie regulable (80mm-120mm) para paneles de laminado 10mm de espesor
- Regelbare voet (80mm-120mm) voor paneel 10mm

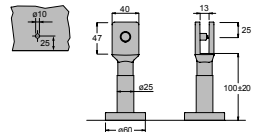
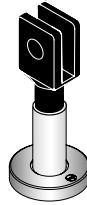

ART.

• 5CM.550.SP13.10

- Piedino (100mm) registrabile (± 20) con pinza per pannello di spessore 13mm
- 100 mm Adjustable foot (± 20 mm) with clamp for 13mm laminate panels
- Pied (100mm) réglable (± 20 mm) avec pince pour panneau épaisseur 13mm
- Regulierbarer Fuss (80mm-120mm) für Laminatpaneel 13mm
- Pie regulable (80mm-120mm) para paneles de laminado 13mm de espesor
- Regelbare voet (80mm-120mm) voor paneel 13mm

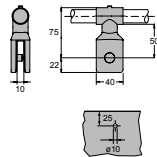

ART.

5CM.551.SP10.10

- Pinza superiore per pannello di spessore 10mm, con innesto tubo in linea o perpendicolare
- Top panel holder for panels 10mm thickness, inline or 90° degrees
- Pince supérieure pour panneau épaisseur 10mm, avec raccord tube en ligne ou perpendiculaire
- Oberer Halter zur Befestigung Panele 10mm, Rohreinsatz 90° versetzt oder in Linie
- Pinza superior para fijación de panel 10mm con racor para tubo perpendicular o in linea
- Boven paneel 10mm bevestigingsklem met loodrechte buisverbinding of in lijn

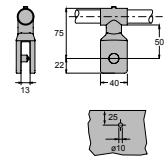

ART.

5CM.551.SP13.10

- Pinza superiore per pannello di spessore 13mm, con innesto tubo in linea o perpendicolare
- Top panel holder for panels 13mm thickness, inline or 90° degrees
- Pince supérieure pour panneau épaisseur 13mm, avec raccord tube en ligne ou perpendiculaire
- Oberer Halter zur Befestigung Panele 13mm, Rohreinsatz 90° versetzt oder in Linie
- Pinza superior para fijación de panel 13mm con racor para tubo perpendicular o in linea
- Boven paneel 13mm bevestigingsklem met loodrechte buisverbinding of in lijn

XX = FINITURA
FINISH
FINITION
AFWERKING
AUSFÜHRUNG

* DOTAZIONE PER FISSAGGI INCLUSA
FIXING KIT INCLUDED
EQUIPEMENT POUR LES FIXATIONS FOURNIES
BEVESTIGINGS INBOEGE
BEVESTIGINGSSET INCLUSIEF

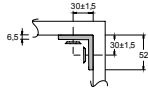

ART.

* 5CM.552.0000.10

- Angolare per fissaggio
- Angle bracket to fix panels
- Equerre pour fixation
- Winkel zur Befestigung Panele
- Escuadra para fijación de paneles
- Paneel bevestigingshoek

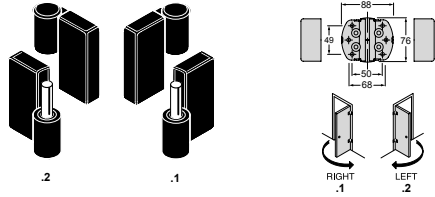

ART.

* 5CM.553.0000.10.2 Sinistra / Left / Gauche / Links / Izquierda / Links
 * 5CM.553.0000.10.1 Destra / Right / Droite / Rechts / Derecha / Rechts

- Cerniera coplanare
- Coplanar hinge for hand panels
- Charnière applique
- Gleitscharnier für Panele
- Bisagra para paneles
- Scharnier voor paneel

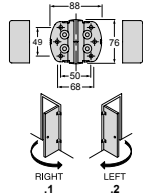
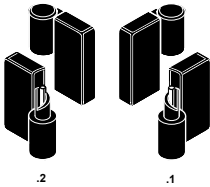

ART.

* 5CM.554.000A.10.2 Sinistra / Left / Gauche / Links / Izquierda / Links
 * 5CM.554.000A.10.1 Destra / Right / Droite / Rechts / Derecha / Rechts

- Cerniera coplanare autoaprente
- Self-opening coplanar hinge for hand panels
- Charnière applique à ouverture automatique
- Gleitscharnier für Panele selbstöffnend
- Bisagra para paneles de auto-apertura
- Scharnier voor paneel voor automatisch openende deur

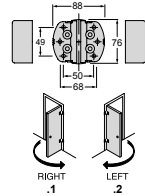
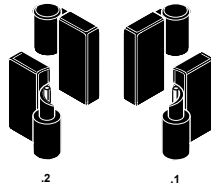

ART.

* 5CM.554.000C.10.2 Sinistra / Left / Gauche / Links / Izquierda / Links
 * 5CM.554.000C.10.1 Destra / Right / Droite / Rechts / Derecha / Rechts

- Cerniera coplanare autochudente
- Self-closing coplanar hinge for hand panels
- Charnière applique à fermeture automatique
- Gleitscharnier für Panele selbstöffnend
- Bisagra para paneles de auto-cierre
- Scharnier voor paneel voor automatisch sluitende deur

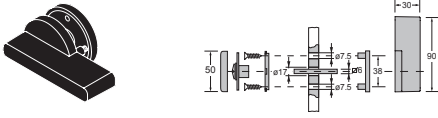

ART.

5CN.558.00LE.10

- Chiusino libero/occupato con leva
- Snib with vacant/engaged indicator and locking lever
- Dispositif de fermeture libre/occupé avec levier
- Frei-Besetzt Garnitur mit Verriegelung
- Muletilla libre/ocupado con manilla de cierre para puerta
- Vrij/bezet eenheid met grendel

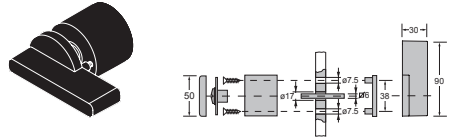

ART.

5CN.559.00LE.10

- Chiusino libero/occupato con leva e pomolo
- Snib with vacant/engaged indicator, locking lever and door knob
- Dispositif de fermeture libre/occupé avec levier et bouton
- Frei-Besetzt Garnitur mit Verriegelung und Türkнопf
- Muletilla libre/ocupado con manilla de cierre para puerta y pomolo
- Vrij/bezet eenheid met grendel en knop



ART.

5CS.558.0LEE.44

- Chiusino libero/occupato con leva in alluminio
- Snib with vacant/engaged indicator with aluminium lever
- Dispositif de fermeture libre/occupé avec levier en aluminium
- Frei-Besetzt Garnitur mit Griff in Aluminium
- Muletilla libre/ocupado con manilla de cierre para puerta de aluminio
- Vrij/bezet eenheid met grendel voor aluminium deur

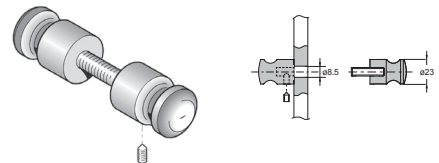

ART.

5CS.564.000D.44

- Pomolo doppio e fisso
- Double fixed knob
- Bouton double et fixe
- Doppelter Türkнопf für Panele
- Doble pomolo para panel
- Dubbele knop voor paneel

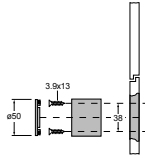
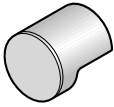

ART.

5CN.564.0000.10

- Pomolo fisso
- Fixed knob
- Bouton fixe
- Türkknopf feststehend
- Pomo fijo
- Vaste knop

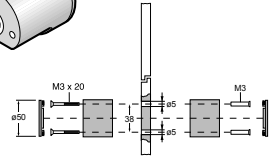
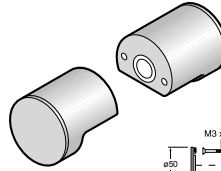

ART.

5CN.564.000D.10

- Appendiabiti
- Cloth hook
- Portemanteau
- Kleiderhaken einfach
- Colgador para panel
- Kapstok

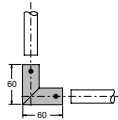
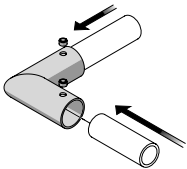

ART.

5CM.556.0000.44

- Giunto a 90° a 2 vie, per unione art.5CS.560.0000
- 90° degree top joint, two way, to suit art.5CS.560.0000
- Raccord 90° 2 voies pour jonction art.5CS.560.0000
- Verbindungselement 22mm - Rohr 22mm 2 seitig 90°
- Codo 90° - tubo 22mm
- Verbindung 22mm - buis 22mm 2 richtingen 90°

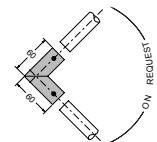
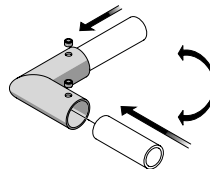

ART.

5CM.557.9999.44

- Giunto, con angolo a richiesta, a 2 vie, per unione art.5CS.560.0000
- Universal top joint, two way, to suit art.5CS.560.0000, please state angle required
- Raccord, avec angle sur demande, 2 voies pour jonction art.5CS.560.0000
- Verbindungselement 22mm - Rohr 22mm 2 seitig, Winkel auf Anfrage
- Codo especial angulo a medida - tubo 22mm
- Verbindung 22mm - buis 22mm 2 richtingen - hoek volgens opgave

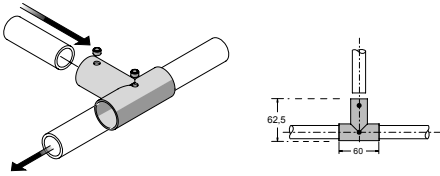

ART.

5CM.561.0000.44

- Giunto a 3 vie per unione art.5CS.560.0000
- Top T-joint, three way, to suit art.5CS.560.0000
- Raccord 3 voies pour jonction art.5CS.560.0000
- Verbindungselement 22mm - Rohr 22mm 3 seitig
- Unión en T - tubo 22mm
- Verbindingsstuk 3 wegs voor buis 22mm

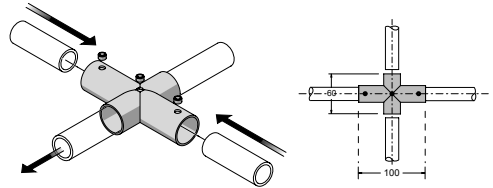

ART.

5CM.561.000B.44

- Giunto a 4 vie per unione art.5CS.560.0000
- Top X-joint, four way, to suit art.5CS.560.0000
- Raccord 4 voies pour jonction art.5CS.560.0000
- Verbindungselement 22mm - Rohr 22mm 4 seitig
- Unión en X cruce para tubo 22mm
- Verbindingsstuk 4 wegs voor buis 22mm

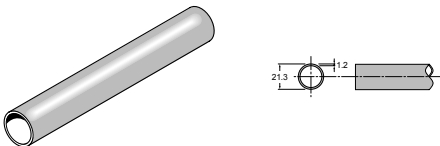

ART.

5CS.560.0000.44

- Tubo superiore in barre da 3 metri
- Top rail tube, 3 metres long
- Tube supérieur en barre de 3 mètres
- Oberes Stützrohr 21,3 mm, 3 Meter
- Tubo superior de soporte, diámetro 21,3 mm, 3 metros
- Steunbuis boven 21,3 mm, lengte 3 meter

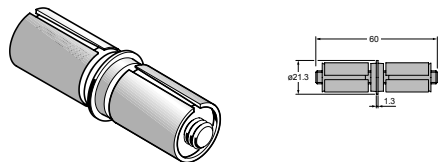

ART.

5CS.563.0000.00

- Giunzione per unione art.5CS.560.0000 con art.5CS.560.0000
- Tube connector, expanding plug to suit art.5CS.560.0000 connection
- Raccord pour jonction art.5CS.560.0000 avec art.5CS.560.0000
- Expansions - Verbindungselement Rohr 22mm - Rohr 22mm
- Unión para tubo 22mm - tubo 22mm de expansión
- Rechte verbinding voor buis 22mm uitbreiding

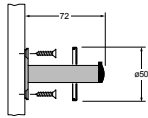
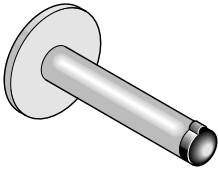

ART.

5CS.562.0000.44

- Appendiabiti/fermaporta
- Door-stop and clothes hook
- Butoir portemanteau
- Türstopper Kleiderhaken
- Tope de puerta colgador
- Deurstop-kledinghanger

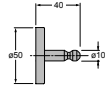
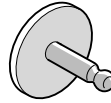

ART.

4CS.488.0000.44

- Appendiabiti
- Cloth hook
- Portemanteau
- Kleiderhaken einfach
- Colgador sencillo
- Kleerhanger enkel

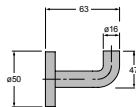
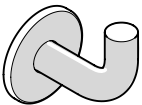

ART.

4CS.488.000C.44

- Appendiabiti
- Cloth hook
- Portemanteau
- Kleiderhaken einfach
- Colgador sencillo
- Kleerhanger enkel

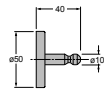
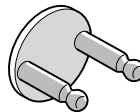

ART.

4CS.488.000D.44

- Appendiabiti
- Cloth hook
- Portemanteau
- Kleiderhaken einfach
- Colgador sencillo
- Kleerhanger enkel

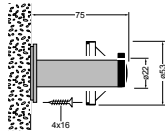
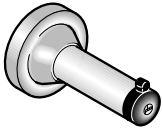

ART.

5CN.562.0000.10

- Appendiabiti/fermaporta
- Door-stop and clothes hook
- Butoir portemanteau
- Türstopper
- Tope para puerta
- Deurstop

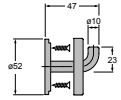

ART.

4CN.488.000P.10

- Appendiabiti
- Cloth hook
- Portemanteau
- Kleiner Kleiderhaken für Panele
- Colgador pequeño para panel
- Kleerhanger dubbel voor paneel

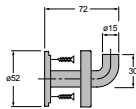

ART.

4CN.488.0000.10

- Appendiabiti
- Cloth hook
- Portemanteau
- Kleiner Kleiderhaken für Panele
- Colgador pequeño para panel
- Kleerhanger dubbel voor paneel

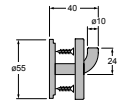
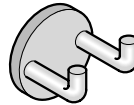

ART.

4CN.488.000D.10

- Appendiabiti
- Cloth hook
- Portemanteau
- Kleiner Kleiderhaken für Panele
- Colgador pequeño para panel
- Kleerhanger dubbel voor paneel

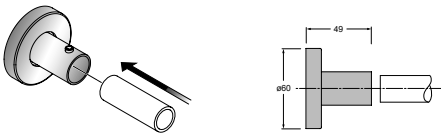

ART.

* 5CM.555.0000.44

- Rosetta registrabile per fissaggio art.5CS.560.0000 a parete
- Adjustable wall fixing rose for art.5CS.560.0000
- Rosace réglable pour fixation art.5CS.560.0000 à paroi
- Befestigungsrosette Rohr 21,3 mm auf Wand regulierbar
- Roseta de fijación de tubo 21,3 mm en pared de giro libre
- Rozet voor muurbevestiging buis 21,3 mm regelbaar

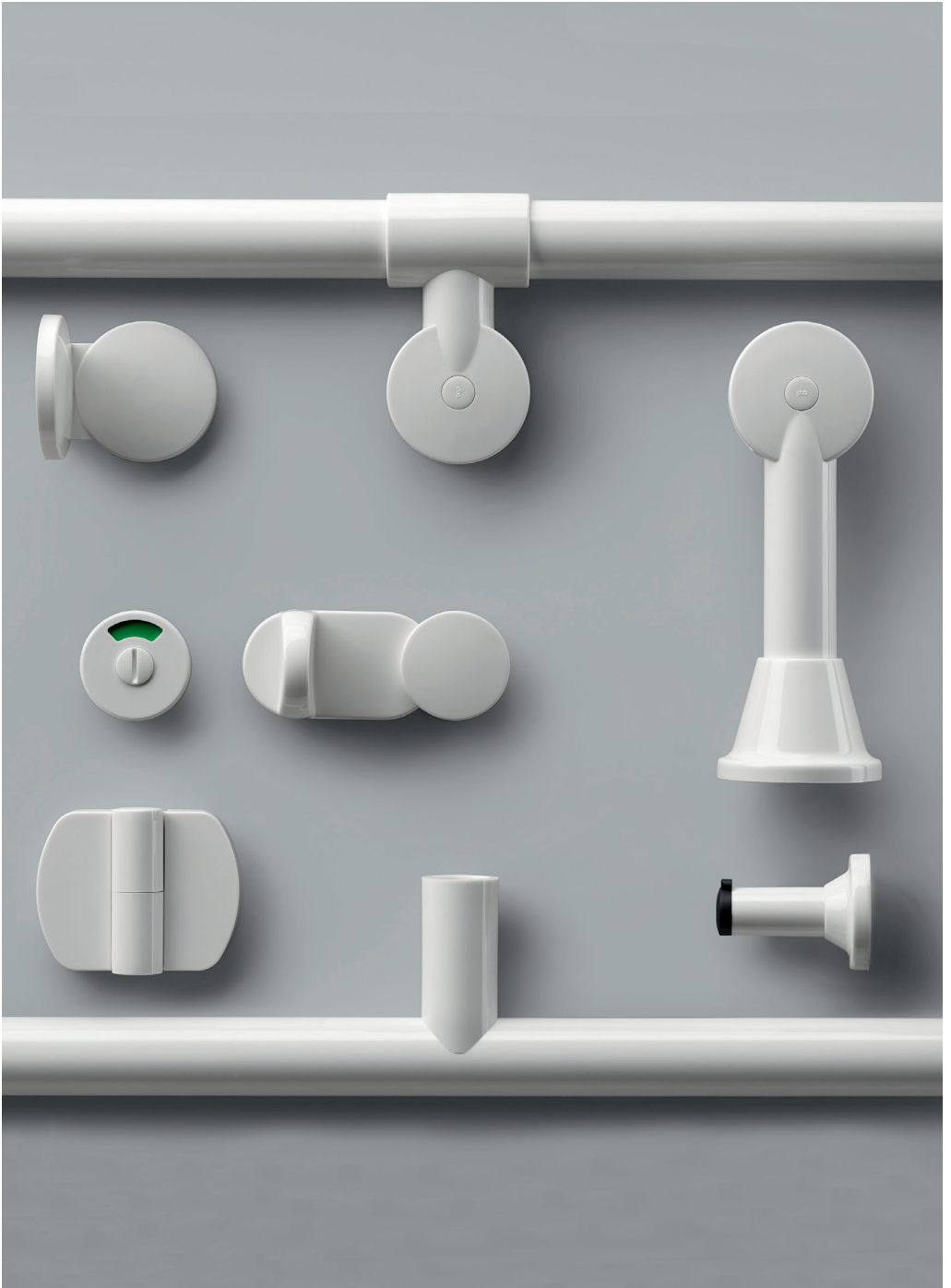

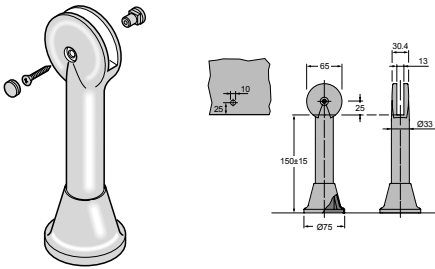

ART.

5CN.550.0000. ...

- Piedino (150mm) registrabile (± 15) con pinza per pannello di spessore 13mm
- 150 mm Adjustable foot (± 15 mm) with clamp for 13mm laminate panels
- Pied (150mm) réglable (± 15 mm) avec pince pour panneau épaisseur 13mm
- Regulierbarer Fuss (135-165mm) für Laminatpaneele 13mm
- Pie regulable (135mm-165mm) para paneles de laminado 13mm de espesor
- Regelbare voet (135-165mm) voor paneel 13mm

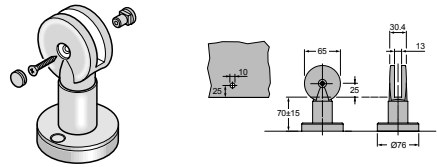

ART.

5CN.550.000T. ...

- Piedino ribassato (70mm) registrabile (± 15) con pinza per pannello di spessore 13mm
- 70mm Adjustable lower foot (± 15 mm) with clamp for 13mm panels
- Pied surbaissé (70mm) réglable (± 15 mm) avec pince pour panneau épaisseur 13mm
- Regulierbarer Fuss (55-85 mm) für Panele 13mm
- Pie regulable rebajado (55-85mm) para paneles 13mm
- Lage regelbare voet (55-85mm) voor paneel 13mm

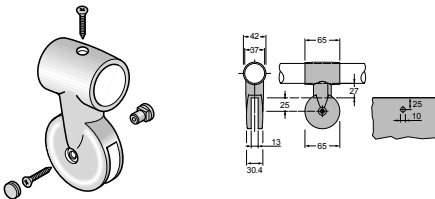

ART.

5CN.551.0010. ...

- Pinza superiore per pannello di spessore 13mm, con innesto tubo in linea
- Inline top panel holder for panels, 13mm thickness
- Pince supérieure pour panneau épaisseur 13mm, avec raccord tube en ligne
- Oberer Halter zur Befestigung Panele 13mm
- Pinza superior para fijación de panel 13mm
- Boven paneel 13mm bevestigingsklem

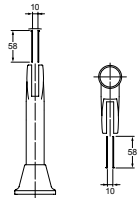
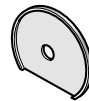

ART.

5CN.550.0010. ...

- Spessore sagomato per piedino e pinza, per pannello di spessore 10 mm
- Shaped shim for foot and panel holder, for panels 10 mm thickness
- Cale de forme pour pied et pince, pour panneau 10 mm
- Geformte Dichtung für Fuss und Scharnier, Panele 10 mm
- Espaciador conformado para pie y pinza para fijación de panel 10 mm
- Verdikkingsplaatje op maat voor voet en paneelhauder, voor paneel 10 mm

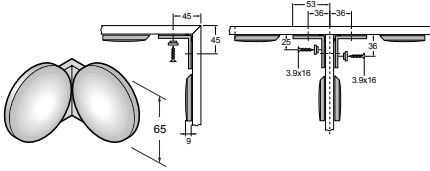

ART.

5CN.552.0000. ...

- Angolare per fissaggio
- Angle bracket to fix panels
- Equerre pour fixation
- Winkel zur Befestigung Panele
- Escuadra para fijación de paneles
- Paneel bevestigingshoek

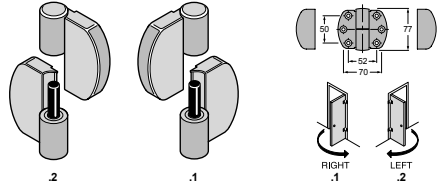

ART.

5CN.553.0000. ... 2 Sinistra / Left / Gauche / Links / Izquierda / Links
5CN.553.0000. ... 1 Destra / Right / Droite / Rechts / Derecha / Rechts

- Cerniera complanare
- Coplanar hinge for hand panels
- Charnière applique
- Gleitscharnier für Panele
- Bisagra para paneles
- Scharnier voor paneel

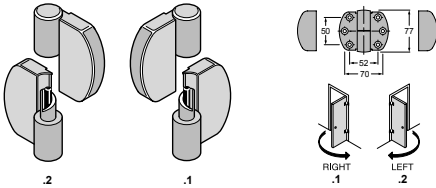

ART.

5CN.554.000A. ... 2 Sinistra / Left / Gauche / Links / Izquierda / Links
5CN.554.000A. ... 1 Destra / Right / Droite / Rechts / Derecha / Rechts

- Cerniera complanare autoaprente
- Self-opening coplanar hinge for hand panels
- Charnière applique à ouverture automatique
- Gleitscharnier für Panele selbstöffnend
- Bisagra para paneles de auto-apertura
- Scharnier voor paneel voor automatisch openende deur

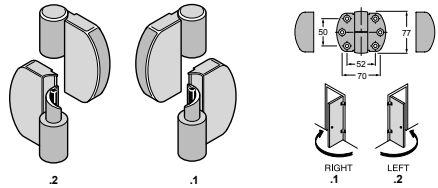

ART.

5CN.554.000C. ... 2 Sinistra / Left / Gauche / Links / Izquierda / Links
5CN.554.000C. ... 1 Destra / Right / Droite / Rechts / Derecha / Rechts

- Cerniera complanare autochudente
- Self-closing coplanar hinge for hand panels
- Charnière applique à fermeture automatique
- Gleitscharnier für Panele selbstöffnend
- Bisagra para paneles de auto-cierre
- Scharnier voor paneel voor automatisch sluitende deur

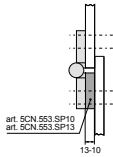
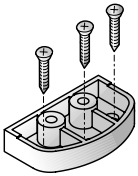

ART.

5CN.553.SP13... (13 mm)

5CN.553.SP10... (10 mm)

- Spessore sagomato per cerniere
- Shaped shim for hinges
- Cale de forme pour charnière
- Geformte Dichtung für Scharnier
- Espaciador conformado para bisagras
- Verdikkingsplaatje op maat voor scharnieren

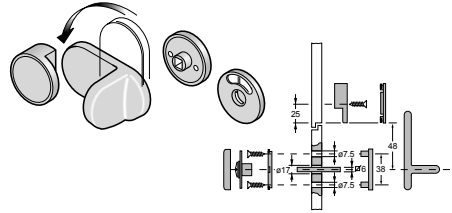

ART.

5CN.558.0000... ..

- Chiusino libero/occupato con leva
- Snib with vacant/engaged indicator and locking lever
- Dispositif de fermeture libre/occupé avec levier
- Frei-Besetzt Garnitur mit Verriegelung
- Muletilla libre/ocupado con manilla de cierre para puerta
- Vrij/bezet eenheid met grendel

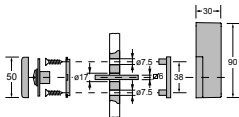
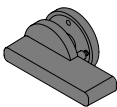

ART.

5CN.558.00LE... ..

- Chiusino libero/occupato con leva
- Snib with vacant/engaged indicator and locking lever
- Dispositif de fermeture libre/occupé avec levier
- Frei-Besetzt Garnitur mit Verriegelung
- Muletilla libre/ocupado con manilla de cierre para puerta
- Vrij/bezet eenheid met grendel

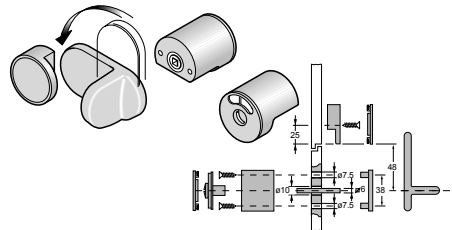

ART.

5CN.559.0000... ..

- Chiusino libero/occupato con leva e pomolo
- Snib with vacant/engaged indicator, locking lever and door knob
- Dispositif de fermeture libre/occupé avec levier et bouton
- Frei-Besetzt Garnitur mit Verriegelung und Türknopf
- Muletilla libre/ocupado con manilla de cierre para puerta y pomo
- Vrij/bezet eenheid met grendel en knop

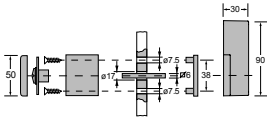
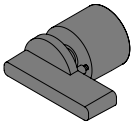

ART.

5CN.559.00LE. ...

- Chiusino libero/occupato con leva e pomolo
- Snib with vacant/engaged indicator, locking lever and door knob
- Dispositif de fermeture libre/occupé avec levier et bouton
- Frei-Besetzt Garnitur mit Verriegelung und Türkнопf
- Muletilla libre/ocupado con manilla de cierre para puerta y pomo
- Vrij/bezet eenheid met grendel en knop

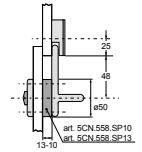
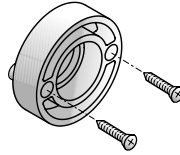

ART.

5CN.558.SP13 ... (13 mm)
5CN.558.SP10 ... (10 mm)

- Spessore sagomato per chiusini
- Shaped shim for snib indicators
- Cale de forme pour verrou
- Geformte Dichtung für Verriegelung
- Espaciador conformado para muletillas
- Verdikkingsplaatje op maat voor WC vergrendeling

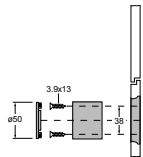
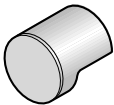

ART.

5CN.564.0000. ...

- Pomolo fisso
- Fixed knob
- Bouton fixe
- Türkнопf feststehend
- Pomo fijo
- Vaste knop

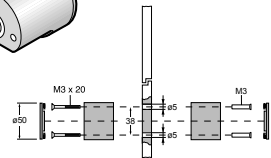
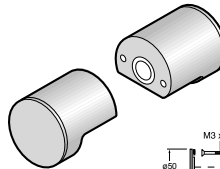

ART.

5CN.564.000D. ...

- Pomolo doppio e fisso
- Double fixed knob
- Bouton double et fixe
- Doppelter Türkнопf für Glastüren
- Doble pomo para puerta de cristal
- Dubbele knop voor glazen deur

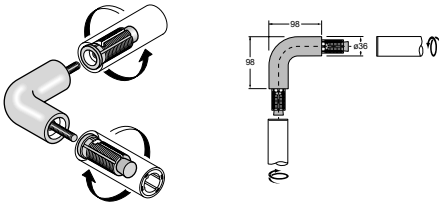

ART.

5CN.556.0000 ..

- Curva di giunzione 90°
- 90° bend for tube connection
- Coude pour raccord à 90°
- Rohrverbindungsbogen 90°
- Codo para tubos a 90°
- Hoekverbinding 90°

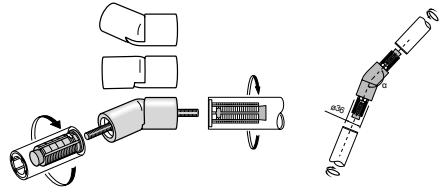

ART.

α

5CN.557.000V ..	150° - 180°
5CN.557.00VA ..	120° - 150°
5CN.557.00VB ..	90° - 120°

- Snodo di giunzione
- Articulated universal bend
- Piece d'assemblage tube
- Gelenkverbindung Rohr
- Codo articulado para tubos
- Verbindungsstuka

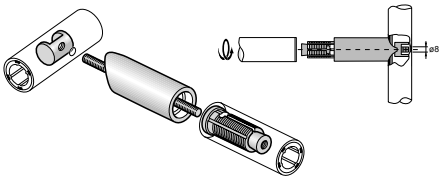

ART.

5CN.561.0000 ..

- Giunto a 3 vie per unione art.5CN.560.0000
- Top T-joint for art.5CN.560.0000 connection
- Raccord à 3 voies pour jonction art.5CN.560.0000
- Verbindungselement für Rohrverbinder, T-Form
- Unión en T para tubo
- Loodrecht T verbindingstuk

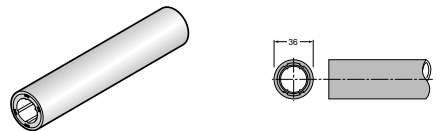

ART.

5CN.560.0000 ..

- Tubo superiore in barre da 4 metri
- Top rail tube, 4 metres long
- Tube superieur en barre de 4 mètres
- Rohr Durchmesser 36mm mit Aluminiumkern, 4 Meter
- Tubo 36mm de diámetro con interior de aluminio, 4 metros
- Buis diameter 36mm met aluminium kern, 4 meter

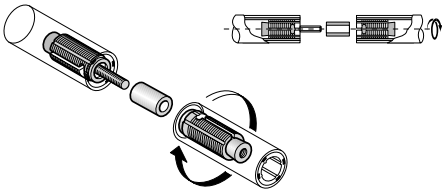

ART.

5CN.563.0000.00

- Giunzione per unione art.5CN.560.0000 con art.5CN.560.0000
- Tube connection for expanding plug tube, suitable for art.5CN.560.0000
- Raccord pour jonction art.5CN.560.0000 avec art.5CN.560.0000
- Rohr Expansions - Verbindungselement
- Unión para tubo - tubo de expansión
- Verbindingsstuk uitbreiding

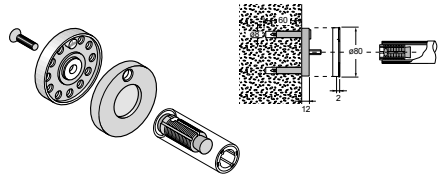

ART.

5CN.555.0000. ...

- Rosetta per fissaggio art.5CN.560.0000 a parete
- Tube-wall fixing rose suitable for art.5CN.560.0000
- Rosace pour fixation art.5CN.560.0000 à paroi
- Befestigungsrosette Rohr / Mauer
- Roseta de fijación de tubo en pared
- Rozet voor muurbevestiging buis

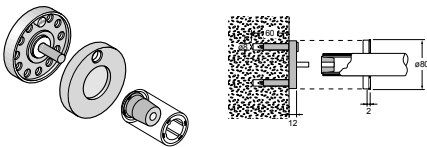

ART.

5CN.555.000S. ...

- Rosetta registrabile per fissaggio art.5CN.560.0000 a parete
- Adjustable tube-wall fixing rose for art.5CN.560.0000
- Rosace réglable pour fixation art.5CN.560.0000 à paroi
- Befestigungsrosette Rohr / Mauer regulierbar
- Roseta de fijación de tubo en pared de giro libre
- Rozet voor muurbevestiging buis regelbaar



ART.

5CN.562.0000. ...

- Appendiabiti/fermaporta
- Door-stop and clothes hook
- Butoir portemanteau
- Türstopper
- Tope para puerta
- Deurstop

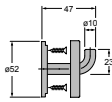

ART.

4CN.488.000P. ..

- Appendiabiti
- Cloth hook
- Portemanteau
- Kleiner Kleiderhaken für Panele
- Colgador pequeño para panel
- Kleerhanger dubbel voor paneel

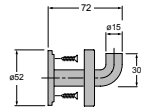

ART.

4CN.488.0000. ..

- Appendiabiti
- Cloth hook
- Portemanteau
- Kleiner Kleiderhaken für Panele
- Colgador pequeño para panel
- Kleerhanger dubbel voor paneel

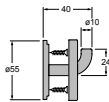
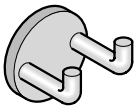

ART.

4CN.488.000D. ..

- Appendiabiti
- Cloth hook
- Portemanteau
- Kleiner Kleiderhaken für Panele
- Colgador pequeño para panel
- Kleerhanger dubbel voor paneel

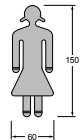
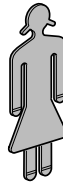

ART.

4CN.494.0000. ..

- Pittogramma
- Pictogram
- Pictogramme
- Piktogramm Frau
- Pictograma mujer
- Pictogram vrouw

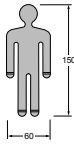
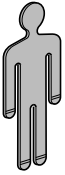

ART.

4CN.495.0000. ..

- Pittogramma
- Pictogram
- Pictogramme
- Piktogramm Mann
- Pictograma hombre
- Pictogram man



ART.

4CN.496.0000. ..

- Pittogramma
- Pictogram
- Pictogramme
- Piktogramm zum weiteren Einsatz
- Pictograma minusválido
- Pictogram anders valide



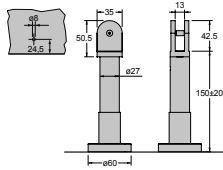
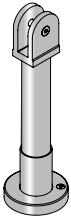

ART.

5CA.550.0000.62

- Piedino (150mm) registrabile (± 20 mm) con pinza per pannello di spessore 13mm
- 150 mm Adjustable foot (± 20 mm) with clamp for 13mm laminate panels
- Pied (150mm) réglable (± 20 mm) avec pince pour panneau 13mm
- Regulierbarer Fuss (130-170mm) für Laminatpaneele Stärke 13mm
- Pie regulable (130-170mm) para paneles de laminado 13mm de espesor
- Regelbare voet (130-170mm) voor paneel met koppelingsring (dikte 18mm min)

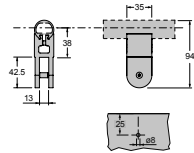
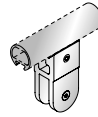

ART.

5CA.551.0000.62

- Pinza superiore per pannello di spessore 13 mm, con innesto tubo in linea
- Inline top panel holder for panels, 13 mm thickness
- Pince supérieure pour panneau 13 mm avec raccord tube en ligne
- Oberer Halter zur Befestigung Panele 13 mm
- Pinza superior para fijación de panel 13 mm
- Boven paneelklem, 13 mm met loodrechte buisverbinding

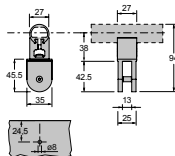
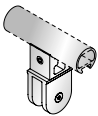

ART.

5CA.551.0000B.62

- Pinza superiore per pannello di spessore 13 mm, con innesto tubo perpendicolare
- Top panel holder, 90°, for panels 13 mm thickness
- Pince supérieure pour panneau 13 mm avec raccord tube perpendiculaire
- Oberer Halter zur Befestigung, Panele 13 mm ; Rohreinsatz 90° versetzt
- Pinza superior para fijación de panel 13 mm con racor para tubo perpendicular
- Boven paneelklem, 13mm met dwarse buisverbinding

ART.

5CA.550.0010.00

- Spessore sagomato per piedino e pinza, per pannello di spessore 10 mm
- Shaped shim for foot and panel holder, for panels 10 mm thickness
- Cale de forme pour pied et pince, pour panneau 10 mm
- Geformte Dichtung für Fuss und Scharnier, Panele 10 mm
- Espaciador conformado para pie y pinza para fijación de panel 10 mm
- Verdikkingsplaatje op maat voor voet en paneelhauder, voor paneel 10 mm

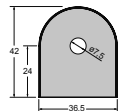
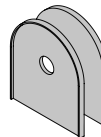

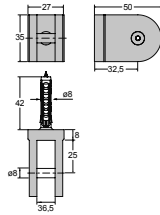
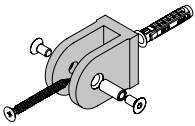

ART.

5CA.551.000C.62

- Pinza a muro
- Wall panel holder
- Pince à mur
- Oberer Halter zur Wandbefestigung
- pinza a pared para panel
- Muur houder

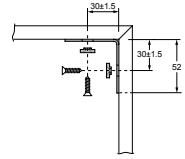
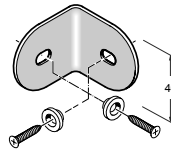

ART.

5CA.552.0000.62

- Angolare per fissaggio
- Angle bracket to fix panels
- Equerre de fixation
- Winkel zur Befestigung Panele
- Escuadra para fijación de paneles
- Paneel bevestigingshoek

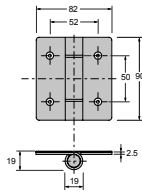
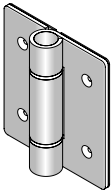

ART.

5CA.553.0000.62

- Cerniera complanare
- Coplanar hinge
- Charnière applique
- Gleitscharnier für Panele
- Bisagra normal para paneles
- Scharnier voor paneel deur

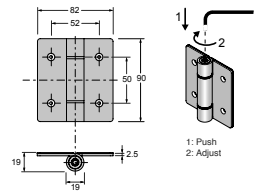
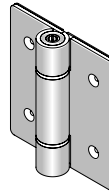

ART.

5CA.554.000C.62

- Cerniera complanare autochiudente
- Self closing coplanar hinge
- Charnière Applique de fermeture automatique
- Gleitscharnier selbstschließend für Panele
- Bisagra con resorte para paneles
- Scharnier voor zelfsluitende paneel deur

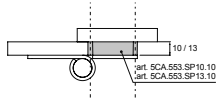
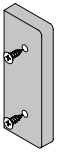

ART.

5CA.553.SP10.10

5CA.553.SP13.10

- Spessore sagomato per cerniere
- Shaped shim for hinges
- Cale de forme pour charnière
- Geformte Dichtung für Scharnier
- Espaciador conformado para bisagras
- Verdikkingsplaatje op maat voor scharnieren

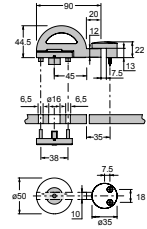
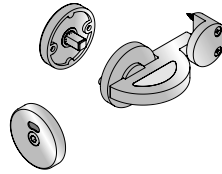

ART.

5CA.558.0000.62

- Chiusino libero/occupato con chiusura su fermo
- Snib with vacant/engaged indicator and spindle
- Dispositif de fermeture libre/occupé avec tige de fermeture sur gache
- Frei-Besetzt Garnitur mit feststehender Verriegelung
- Muletilla libre/ocupado con varilla de cierre sobre tope
- Vrij/bezet eenheid met grendel op sluitplaat

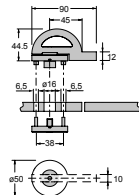
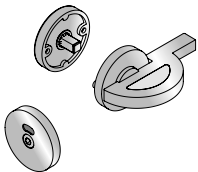

ART.

5CA.558.00LE.62

- Chiusino libero/occupato
- Snib with vacant/engaged indicator
- Dispositif de fermeture libre/occupé
- Frei-Besetzt Garnitur
- Muletilla libre/ocupado
- Vrij/bezet garnituur

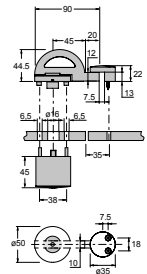
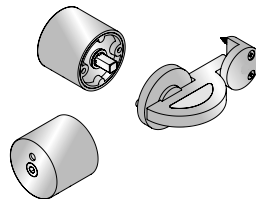

ART.

5CA.559.0000.62

- Chiusino libero/occupato con chiusura su fermo e pomolo
- Snib with vacant/engaged indicator, locking lever and door knob
- Dispositif de fermeture libre/occupé avec gache et bouton
- Frei-Besetzt Garnitur mit feststehender Verriegelung und Türkнопf
- Muletilla libre/ocupado con varilla de cierre sobre tope y pomolo
- Vrij/bezet eenheid met knop en grendel

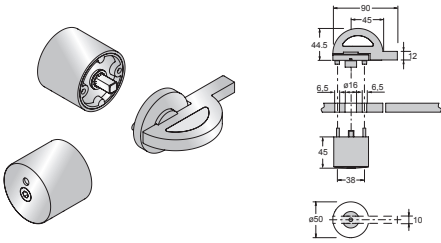

ART.

5CA.559.00LE.62

- Chiusino libero/occupato con pomolo
- Snib with vacant/engaged indicator and knob
- Dispositif de fermeture libre/occupé avec bouton
- Frei-Besetzt Garnitur mit Türknopf
- Muletilla libre/ocupado con pomo
- Vrij/bezet garnituur

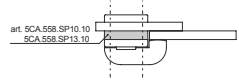
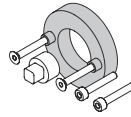

ART.

5CA.558.SP10.10 (10 mm)
5CA.558.SP13.10 (13 mm)

- Spessore sagomato per chiusini
- Shaped shim for snib indicators
- Cale de forme pour verrou
- Geformte Dichtung für Verriegelung
- Espaciador conformado para muletillas
- Verdikkingsplaatje op maat voor WC vergrendeling

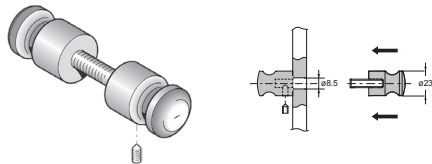

ART.

5CA.564.000D.62

- Pomolo doppio e fisso
- Double fixed knob
- Bouton double et fixe Doppelter
- Türknopf für Panele
- Doble pomo para panel
- Vaste knop dubbel

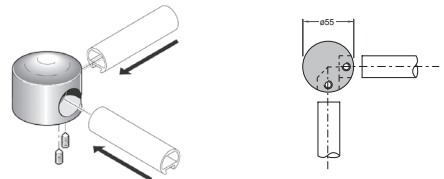

ART.

5CA.556.0000.62

- Giunto a 90° a 2 vie, per unione art.5CA.560.0000
- 90° top joint, two way, to suit art.5CA.560.0000
- Raccord 90° 2 voies, pour union art.5CA.560.0000
- Verbindungselement 25mm - Rohr 25mm 2 seitig 90°
- Codo 90° - tubo 25mm
- Hoekverbinding 90°

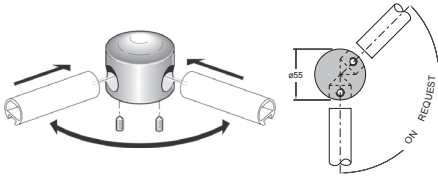

ART.

5CA.557.0000.62

- Giunto, con angolo a richiesta, a 2 vie, per unione art.5CA.560.0000
- Universal top joint, two way, to suit art.5CA.560.0000
- Raccord, avec angle sur demande, 2 voies, pour union art.5CA.560.0000
- Verbindungselement 25mm - Rohr 25mm 2 seitig, Winkel auf Anfrage
- Codo especial angulo a medida- tubo 25mm
- Verbindingsstuk 2 buizen 2 richtingen - hoek volgens opgave

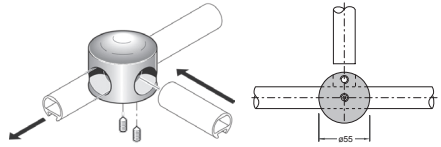

ART.

5CA.561.0000.62

- Giunto a 3 vie per unione art.5CA.560.0000
- Top joint, 3 way, for art.5CA.560.0000 connection
- Raccord - tube 3 voies pour union art.5CA.560.0000
- Verbindungselement 25mm - Rohr 25mm 3 seitig
- Unión en T - tubo 25mm
- Verbindingsstuk 3 wegs voor Alu buis

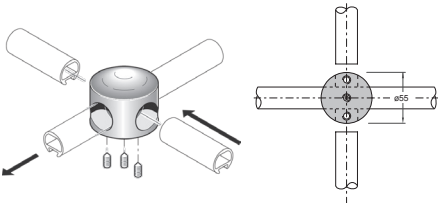

ART.

5CA.561.000B.62

- Giunto a 4 vie per unione art.5CA.560.0000
- Top X-joint, four way, for art.5CA.560.0000 connection
- Raccord - tube 4 voies pour union art.5CA.560.0000
- Verbindungselement 25mm - Rohr 25mm 4 seitig
- Unión en X cruce para tubo 25mm
- Verbindingsstuk 4 wegs voor Alu buis

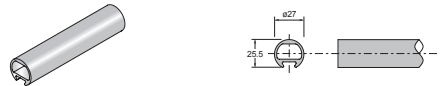

ART.

5CA.560.0000.62

- Tubo superiore in barre da 3 metri
- Top rail tube, 3 metres long
- Tube supérieur de support, 3 mètres
- Oberes Stützrohr 25mm, 3 Meter
- Tubo superior de soporte, diámetro 25mm, 3 metros
- Bovenbuis aluminium 3 meter

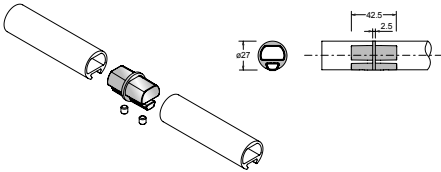

ART.

5CA.563.0000.62

- Giunzione per unione art.5CA.560.0000 con art.5CA.560.0000
- Tube connector, for art.5CA.560.0000 connection
- Raccord tube art.5CA.560.0000 avec art.5CA.560.0000
- Expansions - Verbindungselement Rohr 25mm - Rohr 25mm
- Unión para tubo 25mm - tubo 25mm de expansión
- Vaste knop

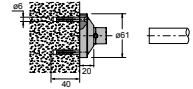
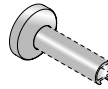

ART.

5CA.555.0000.62

- Rosetta per fissaggio art.5CA.560.0000 a parete
- Tube-wall fixing rose suitable for art.5CA.560.0000
- Rosace de fixation pour art.5CA.560.0000 à paroi
- Befestigungsrosette Rohr 25mm auf Mauer
- Roseta de fijación de tubo 25mm en pared
- Rozet voor muurbevestiging buis

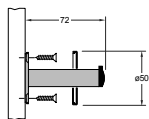
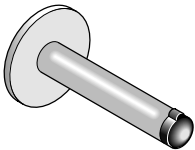

ART.

5CA.562.0000.62

- Appendiabiti/fermaporta
- Door-stop and clothes hook
- Butoir portemanteau
- Türstopper
- Tope de puerta colgador
- kapstok-deurstop

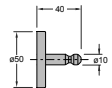
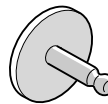

ART.

5CA.588.0000.62

- Appendiabiti
- Cloth hook
- Portemanteau
- Kleiderhaken einfach
- Colgador para panel
- Kapstok

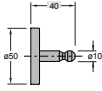
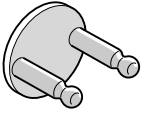

ART.

5CA.588.000D.62

- Appendiabiti
- Cloth hook
- Portemanteau
- Kleiderhaken einfach
- Colgador para panel
- Kapstok

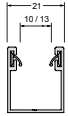

ART.

5CA.593.0000.62 (13 mm)

5CA.593.0010.62 (10 mm)

- Profilo in alluminio per fissaggio pannello/parete e guarnizione in PVC
- Door edge, aluminium profile for fixing panel-wall and door Seal in PVC
- Profil de feuillure en aluminium pour fixation panneau-paroi et joint de feuillure en PVC
- Aluminium Anschlagprofil für Befestigung Paneel-Wand und Anschlagdichtung
- Perfil de alluminio por fijaciones panel-pared y Guarnición en PVC
- Aluminium bevestigingsprofiel voor paneel-wand en guarnición en PVC

INFORMAZIONI TECNICHE

TECHNICAL INFORMATION

TECHNISCHE INFORMATIONEN

INFORMATIONS TECHNIQUES

TECHNISCHE INFORMATIE

IT				* colori indicativi				GB				* indicative colors				FR				* couleurs indicatives																																																																																																												
CODICE - CODE	MATERIALE	FINITURA	.XX *	MATERIAL	FINISH	.XX *	MATERIEL	FINITION	.XX *	MATERIAL	FINISH	.XX *	MATERIEL	FINITION	.XX *	MATERIEL	FINITION	.XX *	MATERIEL	FINITION	.XX *																																																																																																											
01T. KLO.V 2CC. KLO. 2CE. KLS. 2CP. KLH. 2CF. KLP. 2DM. KLR. EDS. 5CG. HGL. 5CS. HGU. 400-SS 400-HR-SS	ACCIAIO INOX AISI 316L	Di produzione: SATINATO A richiesta: LUCIDO A richiesta: PVD su articoli selezionati (*) Black Satin Black Bright Chocolate Satin	.44 .43 .89 .90 .91 .93 .94 .95	STAINLESS STEEL AISI 316L	Standard: SATIN Upon Request: BRIGHT Upon Request: Copper Bronze Bright Copper Bronze Satin Champagne Satin Black Satin Black Bright Chocolate Satin	.44 .43 .89 .90 .91 .93 .94 .95	ACIER INOXIDABLE AISI 316L	Standard: SATINE A la demande: POLI A la demande: Copper Bronze Bright Copper Bronze Satin Champagne Satin Black Satin Black Bright Chocolate Satin	.44 .43 .89 .90 .91 .93 .94 .95	YOD	ACCIAIO INOX AISI 316L + LEGNO	Di produzione: SATINATO + LEGNO Wenge Frassinio Mogano A richiesta: LUCIDO + LEGNO Wenge Frassinio Mogano	.46 .47 .48 .49 .50 .51	STAINLESS STEEL AISI 316L + WOOD	Standard: SATIN + WOOD Upon Request: BRIGHT + WOOD	Wenge Ash Mahogany .46 .47 .48 .49 .50 .51	ACIER INOXIDABLE AISI 316L + BOIS	Standard: SATINE + BOIS A la demande: POLI + BOIS	Wenge Frene Acajou Wenge Frene Acajou .46 .47 .48 .49 .50 .51	YOD KLL	ACCIAIO INOX AISI 316L + PELLE	Di produzione: SATINATO + PELLE Nero Beige Marrone Rosso A richiesta: LUCIDO + PELLE Nero Beige Marrone Rosso	.4A .4B .4C .4D .3A .3B .3C .3D	STAINLESS STEEL AISI 316L + LEATHER	Standard: SATIN + LEATHER Upon Request: BRIGHT + LEATHER	Black Biscuit Brown Red Black Black Brown Red .4A .4B .4C .4D .3A .3B .3C .3D	ACIER INOXIDABLE AISI 316L + CUIR	Standard: SATINE + CUIR A la demande: POLI + CUIR	Noir Beige Marron Rouge Noir Beige Marron Rouge .4A .4B .4C .4D .3A .3B .3C .3D	KLA	ALLUMINIO	Di produzione: ANODIZZATO SATINATO ELOX SATINATO A richiesta: VERNICIATO	Champagne Bronzo Nero .66 .67 .68	ALUMINIUM	Standard: ANODIZED SATIN ELOX SATIN Upon Request: POWDER COATED	Champagne Bronze Black .66 .67 .68	ALUMINIUM	Standard: ANODISE SATINE ELOX SATINE A la demande: LAQUE	Champagne Bronze Noir .66 .67 .68	3CC	NYLON	Di produzione: BIANCO NERO A richiesta: GIALLO BLU GRIGIO VERDE ROSSO	.01 .10 .04 .06 .07 .08 .09	NYLON	Standard: WHITE BLACK Upon Request: YELLOW BLUE GREY GREEN RED	.01 .10 .04 .06 .07 .08 .09	NYLON	Standard: BLANC NOIR A la demande: JAUNE BLEU GRIS VERT ROUGE	.01 .10 .04 .06 .07 .08 .09	M18	ALLUMINIO	Di produzione: VERNICIATO Nero Bianco 1013 Bianco 9010 ANODIZZATO GREZZO A richiesta: ANODIZZATO	Nero Bianco 1013 Bianco 9010 Argento .26 .21 .30 .62 .61 .63 .64	ALUMINIUM	Standard: POWDER COATED ANODIZED UNFINISHED Upon Request: ANODIZED	Black White 1013 White 9010 Silver .26 .21 .30 .62 .61 .63 .64	ALUMINIUM	Standard: LAQUE ANODISE BRUT A la demande: ANODISE	Noir Blanc 1013 Blanc 9010 Argent Bronze Noir .26 .21 .30 .62 .61 .63 .64	PVD	ACCIAIO INOX AISI 316L	PVD LUCIDO	Oro .81	STAINLESS STEEL AISI 316L	BRIGHT PVD	Gold .81	ACIER INOX AISI 316L	POLI PVD	Or .81	5CA 5CN	ALLUMINIO NYLON	ANODIZZATO Di produzione: BIANCO GRIGIO ROSSO NERO	Argento .62 .01 .07 .09 .10	ALUMINIUM NYLON	ANODIZED Standard: WHITE GREY RED BLACK	Silver .62 .01 .07 .09 .10	ALUMINIUM NYLON	ANODISE Standard: BLANC GRIS ROUGE NOIR	Argent .62 .01 .07 .09 .10	5CM	ACCIAIO INOX AISI 316L + NYLON	Di produzione: SATINATO NERO	.44 .10	STAINLESS STEEL AISI 316L + NYLON	Standard: SATIN BLACK	.44 .10	ACIER INOX AISI 316L + NYLON	Standard: SATINE NOIR	.44 .10	400-NY 400-HR-NY	NYLON	BIANCO PLUS BIANCO BISCOTTO GIALLO PASTELLO GIALLO BLU PASTELLO BLU GRIGIO VERDE ROSSO NERO	.A1 .01 .02 .03 .04 .05 .06 .07 .08 .09 .10	NYLON	WHITE PLUS WHITE BISCOTT LIGHT YELLOW YELLOW LIGHT BLUE BLUE GREY GREEN RED BLACK	.A1 .01 .02 .03 .04 .05 .06 .07 .08 .09 .10	NYLON	BLANC PLUS BLANC BISCUIT JAUNE PASTEL JAUNE BLEU PASTEL BLEU GRIS VERT ROUGE NOIR	.A1 .01 .02 .03 .04 .05 .06 .07 .08 .09 .10	CAP	ALLUMINIO VERNICIATO	BIANCO GRIGIO	.30 .24	COATED ALUMINIUM	WHITE GREY	.30 .24	ALUMINIUM LAQUE	BLANC GRIS	.30 .24	400-ALU	ALLUMINIO TUBO ACCESSORI SUPPORTI E CURVE	Alluminio anodizzato bronzo chiaro Nylon grigio Lega verniciata grigio metallizzato	.70	ALUMINIUM RAIL ACCESSORIES SUPPORTS AND BENDS	Aluminium anodized light bronze Nylon grey Powder coated alloy metallic grey	.70	ALUMINIUM TUBE ACCESSOIRES SUPPORTS ET COUDES	Aluminium anodisé bronze clair Nylon gris Alliage laqué gris métallisé	.70	TUBO ACCESSORI SUPPORTI E CURVE	Alluminio anodizzato argento Nylon bianco Lega verniciata bianco	.71	RAIL ACCESSORIES SUPPORTS AND BENDS	Aluminium anodized silver Nylon white Powder coated alloy white	.71	TUBE ACCESSOIRES SUPPORTS ET COUDES	Aluminium anodisé argent Nylon blanc Alliage laqué blanc	.71

DE			* indicative farben			ES			* colores indicativos			NL			* indicatieve colors								
MATERIAL	AUSFÜHRUNG	.XX		MATERIAL	ACABADO	.XX		MATERIAAL	AFWERKINGEN	.XX		MATERIAL	ACABADO	.XX		MATERIAAL	AFWERKINGEN	.XX					
EDELSTAHL ROSTFREI WERKSTOFF 1.4404	Standard: FEIN MATT SATINIERT	.44		ACERO INOXIDABLE AISI 316L	Estándar: MATE	.44		ROESTVAST STAAL AISI 316L	Standaard: MAT GEBORSTELD	.44		EDELSTAHL ROSTFREI WERKSTOFF 1.4404	Standard: FEIN MATT SATINIERT	.44		ROESTVAST STAAL AISI 316L	Standaard: MAT GEBORSTELD	.44		EDELSTAHL ROSTFREI WERKSTOFF 1.4404	Standard: FEIN MATT SATINIERT	.44	
	Auf Anfrage: HOCHGLANZ POLIERT	.43			Bajo pedido: BRILLO	.43			Op aanvraag: BLINKEND GEBORSTELD	.43													
	Auf Anfrage: PVD	.89			Bajo pedido: Copper Bronze Bright	.89			Op aanvraag: MET PVD	.89													
	BESCHICHTET an sellierden Produkten (*)	.90			Copper Bronze Satin Champagne Satin	.90			BEHANDELING voor geselecteerde Artikelen (*)	.90													
		.91			Black Satin	.91				.91													
		.94			Black Bright	.94				.94													
	.95		Chocolate Satin	.95			.95																
EDELSTAHL ROSTFREI WERKSTOFF 1.4404	Standard: FEIN MATT SATINIERT + MASSIVHOLZ	.46		ALUMINIO	Estándar: MATE	.46		ALUMINIO	Standaard: MAT	.46		EDELSTAHL ROSTFREI WERKSTOFF 1.4404	Standard: FEIN MATT SATINIERT + MASSIVHOLZ	.46		ALUMINIO	Standaard: MAT	.46		EDELSTAHL ROSTFREI WERKSTOFF 1.4404	Standard: FEIN MATT SATINIERT + MASSIVHOLZ	.46	
	Auf Anfrage: HOCHGLANZ POLIERT + MASSIVHOLZ	.49			+ MADERA	.49			+ HOUT	.49													
		.50			Bajo pedido: BRILLO + MADERA	.50			Op aanvraag: BLINKEND GEBORSTELD + HOUT	.50													
	.51		Caoba	.51		Caoba	.51																
EDELSTAHL ROSTFREI WERKSTOFF 1.4404	Standard: FEIN MATT SATINIERT + LEDER	.4A		ALUMINIO	Estándar: MATE	.4A		ALUMINIO	Standaard: MAT	.4A		EDELSTAHL ROSTFREI WERKSTOFF 1.4404	Standard: FEIN MATT SATINIERT + LEDER	.4A		ALUMINIO	Standaard: MAT	.4A		EDELSTAHL ROSTFREI WERKSTOFF 1.4404	Standard: FEIN MATT SATINIERT + LEDER	.4A	
	Auf Anfrage: HOCHGLANZ POLIERT + LEDER	.4B			+ CUERO	.4B			+ LEDER	.4B													
		.4C			Negro	.4C			Beige	.4C													
		.4D			Beige	.4D			Marrón	.4D													
		.3A			Negro	.3A			Negro	.3A													
		.3B			Beige	.3B			Beige	.3B													
	.3C		Marrón	.3C		Marrón	.3C																
	.3D		Rojo	.3D		Rojo	.3D																
ALUMINIUM	Standard: ELOXIERT SATINIERT	.66		ALUMINIO	Estándar: ANODIZADO MATE	.66		ALUMINIO	Standaard: GEANODISEERD MAT	.66		ALUMINIUM	Standard: ELOXIERT SATINIERT	.66		ALUMINIO	Standaard: GEANODISEERD MAT	.66		ALUMINIUM	Standard: ELOXIERT SATINIERT	.66	
	Auf Anfrage: LACKIERT	.67			NEGRO	.67			BRONCE	.67													
		.68			MATE	.68			NEGRO	.68													
			Bajo pedido: PINTADO			Bajo pedido: PINTADO																	
NYLON	Standard: WEISS	.01		ALUMINIO	Estándar: BLANCO	.01		ALUMINIO	Standaard: WIT	.01		NYLON	Standard: WEISS	.01		ALUMINIO	Standaard: WIT	.01		NYLON	Standard: WEISS	.01	
	Auf Anfrage: GELB	.04			NEGRO	.04			BRONCE	.04													
		.06			Bajo pedido: AMARILLO	.06			Op aanvraag: GEEL	.06													
		.07			AZUL	.07			BLAUW	.07													
		.08			GRIS	.08			GRIJS	.08													
		.09			VERDE	.09			GROEN	.09													
			ROJO			ROOD																	
ALUMINIUM	Standard: LACKIERT	.26		ALUMINIO	Estándar: PINTADO	.26		ALUMINIO	Standaard: GELAKT	.26		ALUMINIUM	Standard: LACKIERT	.26		ALUMINIO	Standaard: GELAKT	.26		ALUMINIUM	Standard: LACKIERT	.26	
		.21			Blanco 1013	.21			Wit 1013	.21													
		.30			Blanco 9010	.30			Wit 9010	.30													
	.62		Silber	.62		Plata	.62																
	.63		ANODIZADO BRUTO	.63		ANODIZADO BRUTO	.63																
	.64		Bajo pedido: ANODIZADO	.64		Bajo pedido: ANODIZADO	.64																
			Bronce			Bronce																	
			Negro			Negro																	
EDELSTAHL ROSTFREI WE 1.4404	PVD BESCHICHTET	.81		ALUMINIO	Estándar: BLANCO PLUS	.A1		ALUMINIO	Standaard: MET PVD BEHANDELING	.81		EDELSTAHL ROSTFREI WE 1.4404	PVD BESCHICHTET	.81		ALUMINIO	Standaard: MET PVD BEHANDELING	.81		EDELSTAHL ROSTFREI WE 1.4404	PVD BESCHICHTET	.81	
	ELOXIERT	.62			ANODIZADO	.62			Plata	.62													
	Standard: WEISS	.01			Estándar: BLANCO	.01			Estándar: BLANCO	.01													
		.07			GRIS	.07			GRIS	.07													
		.09			ROJO	.09			ROJO	.09													
		.10			NEGRO	.10			NEGRO	.10													
EDELSTAHL ROSTFREI WE 1.4404	Standard: SATINIERT	.44		ALUMINIO	Estándar: MATE	.44		ALUMINIO	Standaard: SATINATO	.44		EDELSTAHL ROSTFREI WE 1.4404	Standard: SATINIERT	.44		ALUMINIO	Standaard: SATINATO	.44		EDELSTAHL ROSTFREI WE 1.4404	Standard: SATINIERT	.44	
	Auf Anfrage: SCHWARZ	.10			+ NYLON	.10			+ NYLON	.10													
					Estándar: NEGRO				Estándar: NEGRO														
NYLON	WEISS PLUS	.A1		ALUMINIO	BLANCO PLUS	.A1		ALUMINIO	WIT PLUS	.A1		NYLON	WEISS PLUS	.A1		ALUMINIO	WIT PLUS	.A1		NYLON	WEISS PLUS	.A1	
	WEISS	.01			BLANCO	.01			BLANCO	.01													
	CREME	.02			BEIGE	.02			BEIGE	.02													
	BLÜTENGELB	.03			AMARILLO PASTEL	.03			AMARILLO PASTEL	.03													
	GELB	.04			AMARILLO	.04			AMARILLO	.04													
	FLIEDERBLAU	.05			AZUL PASTEL	.05			AZUL PASTEL	.05													
	BLAU	.06			AZUL	.06			AZUL	.06													
	GRAU	.07			GRIS	.07			GRIS	.07													
	GRÜN	.08			VERDE	.08			VERDE	.08													
	ROT	.09			ROJO	.09			ROJO	.09													
	SCHWARZ	.10			NEGRO	.10			NEGRO	.10													
	BESCHICHTETEM ALUMINIUM	WEISS	.30			ALUMINIO	BLANCO		.30		ALUMINIO		WIT	.30			BESCHICHTETEM ALUMINIUM	WEISS	.30			ALUMINIO	WIT
GRAU		.24		PINTADO	.24			GRIS	.24														
ALUMINIUM ROHR ZUBEHÖRTEILE STÜTZE UND BÖGEN	Aluminium eloxiert lichtbronze	.70		ALUMINIUM	TUBO	.70		ALUMINIUM	BUIS	.70		ALUMINIUM ROHR ZUBEHÖRTEILE STÜTZE UND BÖGEN	Aluminium eloxiert lichtbronze	.70		ALUMINIUM	BUIS	.70		ALUMINIUM ROHR ZUBEHÖRTEILE STÜTZE UND BÖGEN	Aluminium eloxiert lichtbronze	.70	
	Nylon grau				ACCESORIOS SUPORTES Y CURVAS				ACCESORIOS SUPORTES Y CURVAS														
	Lackierte Legierung metallgrau				Lacado gris metalizado				Lacado gris metalizado														
ROHR ZUBEHÖRTEILE STÜTZE UND BÖGEN	Aluminium eloxiert silber	.71		ALUMINIUM	TUBO	.71		ALUMINIUM	BUIS	.71		ROHR ZUBEHÖRTEILE STÜTZE UND BÖGEN	Aluminium eloxiert silber	.71		ALUMINIUM	BUIS	.71		ROHR ZUBEHÖRTEILE STÜTZE UND BÖGEN	Aluminium eloxiert silber	.71	
	Nylon weiss				ACCESORIOS SUPORTES Y CURVAS				ACCESORIOS SUPORTES Y CURVAS														
	Lackierte Legierung weiss				Lacado blanco				Lacado blanco														

PROGRAMMA 500-GSS / 500-SS / 500-CM

MATERIAI IMPIEGATI - MATERIALS - MATÉRIAUX UTILISÉS - VERWENDETE MATERIALEN - MATERIALES EMPLEADOS - GEBRUIKTE MATERIALEN

Chemical compositions of AISI stainless steel grades

Material - Stainless	C%	Cr%	Ni%	Mo%
AISI 430 (1.4016)	0,12 max	14,0-18,0	/	/
AISI 304 (1.4301)	0,08 max	18,0-20,0	8,0-10,5	/
AISI 316 (1.4401)	0,08 max	16,0-18,0	10,0-14,0	2,00-3,00
AIS 316L (1.4404)*	0,03 max	16,0-18,0	10,0-14,0	2,00-3,00

*Standard PBA

Estimated pit corrosion penetration time - time to penetrate 1 mm (years) by steel type

Location - Stainless Steel	Marine	Semi_industrial	Rural
Stainless Steel AISI 430 (1.4016)	N/A	85	250
Stainless Steel AISI 304 (1.4301)	145	135	770
Stainless Steel AISI 316 (1.4401)	260	525	1200

Source: The British Stainless Steel Association (BSSA)

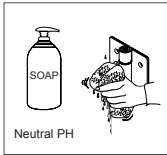

PULIZIA
MAINTENANCE
NETTOYAGE
REINIGINGSAAWIJZINGEN
LIMPIEZA
ONDERHOUD

**CERTIFICAZIONE MATERIALE - MATERIAL CERTIFICATION - CERTIFICATION DU MATÉRIEL - ZURTIFIZIERUNG DES MATERIALS
 CERTIFICACIÓN DEL MATERIAL - CERTIFIËRING VAN HET MATERIAAL**

L'acciaio usato da pba, acciaio inossidabile AISI 316L (1), garantisce il massimo grado di resistenza alla corrosione: normativa di riferimento UNI EN 1670; certificazione ottenuta dopo test di corrosione in nebbia salina secondo UNI ISO 9227.
 (1) X2CrNiMo 17-12-2 secondo designazione EN 10088-3

The AISI 316L stainless steel (1) steel used by pba, meets the requirements of UNI EN 1670, the ultimate quality standard for ensuring resistance to corrosion. Pba has been awarded a certificate for successfully salt spray testing the stainless steel in accordance with UNI ISO 9227.
 (1) X2CrNiMo 17-12-2 as per EN 10088-3

L'acier utilisé par pba, acier inoxydable AISI 316L (1), garantit le degré maximum de résistance à la corrosion: norme de référence UNI EN 1670; certification obtenue après un essai de corrosion par exposition à un brouillard salin conformément à UNI ISO 9227.
 (1) X2CrNiMo 17-12-2 conforme à la désignation EN 10088-3

Das pba Edelstahl rostfrei Werkstoff 1.4404 (1) ist korrosionsbeständig (die höchste Stufe in Bezug auf die Norm UNI EN 1670). Die Zertifizierung wurde nach erfolgreich bestanden Korrosionstesten in Salznebel gemäß UNI ISO 9227 ausgestellt.
 (1) X2CrNiMo 17-12-2 gemäss EN 10088-3

El acero utilizado por pba, acero inoxidable AISI 316L (1), garantiza el grado máximo de resistencia a la corrosión: Normativa UNI EN 1670; certificación obtenida después de una prueba de resistencia contra corrosión en atmósfera de neblinas salinas según los estándares UNI ISO 9227.
 (1) X2CrNiMo 17-12-2 como en EN 10088-3

Labotests hebben aangetoond dat pba deurkrukken van de serie 400-SS in roestvast staal AISI 316L (1) een uitermate hoge roestweerstand garanderen (graad 4 - de hoogst bereikbare graad voor de Europese norm UNI EN 1670). Het certificaat wordt toegekend na weerstandstests in de zoutnevels, uitgevoerd volgens de normering UNI ISO 9227.
 (1) X2CrNiMo 17-12-2 volgens de norm EN 10088-3

PROGRAMMA 500-ALU
MATERIALI IMPIEGATI - MATERIALS - MATÉRIAUX UTILISÉS - VERWENDETE MATERIELEN - MATERIALES EMPLEADOS - GEBRUIKTE MATERIELEN

Lega utilizzata di alluminio: 6060
 Trattamento superficiale: ossidazione anodica spessore 8-10 µm
 Stato metallurgico: T5

Aluminium - Legierungen: 6060
 Oberflächenbehandlung: anodische Oxydation 8-10 µm
 Werkstoffzustände: T5

Aluminium alloy employed in the manufacture of these products: 6060
 Surface treatment: anodic oxidation at a thickness of 8-10 µm
 Temper: T5

Aleación de aluminio utilizada: 6060
 Tratamiento superficial: oxidación anódica, grosor 8-10 µm
 Estados de tratamiento: T5

Alliage d' aluminium utilise: 6060
 Traitement de surface: oxydation anodique, épaisseur 8-10 µm
 Etats métallurgiques: T5

Gebruikte aluminiumlegering 6060
 Oppervlaktebehandeling: anode-oxidatie dikte 8-10 µm
 Toestandsaanduidingen: T5

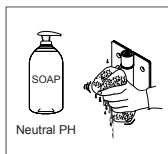

PULIZIA
MAINTENANCE
NETTOYAGE
REINIGINGSAANWIJZINGEN
LIMPIEZA
ONDERHOUD

PROGRAMMA 500-NY / 500-CM
MATERIALI IMPIEGATI - MATERIALS - MATÉRIAUX UTILISÉS - VERWENDETE MATERIELEN - MATERIALES EMPLEADOS - GEBRUIKTE MATERIELEN

- Resina termoplastica (Poliammide 6).
- Alta resistenza meccanica.
- Tenacità agli urti.
- Resistenza ad usura e abrasione.
- Classificata come autoestinguenze di categoria UL 94V-2.
 E non emana gas tossici.

- Thermoplastisches Harz (Polyamid 6):
- Hohe mechanische Widerstandsfähigkeit.
- Unzerstörbar gegenüber üblichen Schlagbeanspruchungen.
- Widerstandsfähigkeit gegen Verschleiss und Abnutzung durch Reibung.
- Selbstverlöschend in der Kategorie UL 94 V-2 klassifiziert.
 Es entstehen keine toxischen Gase.

- Thermoplastic resin (Polyamide 6).
- High mechanical resistance.
- Tenacity.
- Resistance to wear and abrasion.
- Classified as self-extinguishable into category UL 94V-2.
 It does not generate toxic gases.

- Resina de termoplástico (Poliamida 6).
- Alta resistencia mecánica.
- Resistencia contra impactos.
- Resistencia a desgaste y abrasión.
- Clasificada como auto-extinguible de clase UL 94V-2.
 Y no emana gas tóxicos.

- Résine thermoplastique (Polyamide 6).
- Résistance mécanique élevée.
- Grande résistance aux chocs.
- Résistance à l'usure et à l'abrasion.
- Classée comme auto-extinguible de catégorie UL 94V-2.
 Ne libère pas de gaz toxiques.

- POLYAMIDE 6 (thermoplastische kunststof)
- Hoge mechanische weerstand stootvast
- Gebruiksvriendelijk en onderhoudsvriendelijk
- Geklasseerd als zelfdovend onder categorie UL94V-S

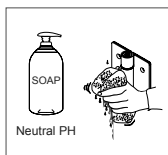

PULIZIA
MAINTENANCE
NETTOYAGE
REINIGINGSAANWIJZINGEN
LIMPIEZA
ONDERHOUD

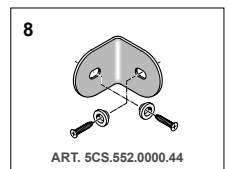
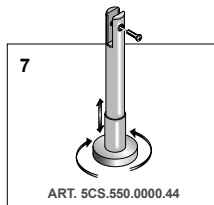
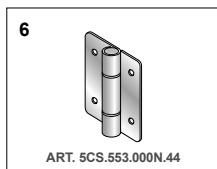
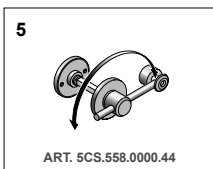
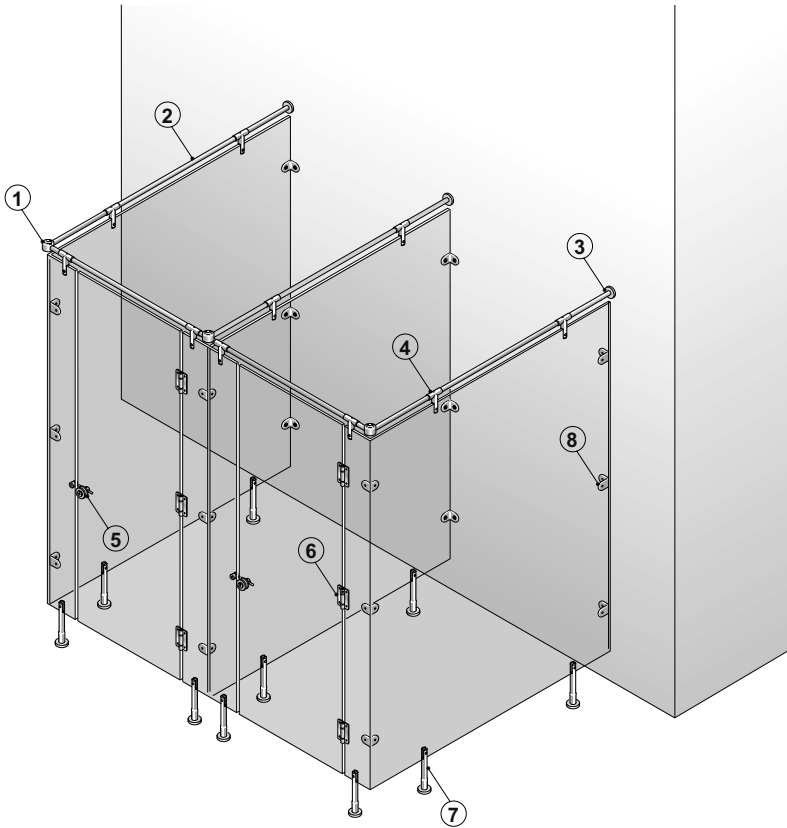
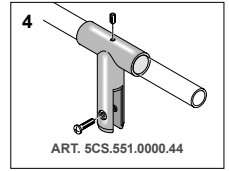
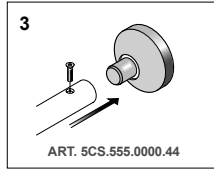
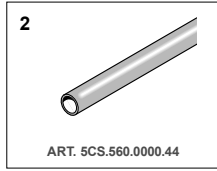
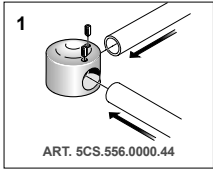

RILIEVO MISURE PER UNA CORRETTA INSTALLAZIONE DEL TUBO SUPERIORE / TAKING MEASUREMENTS FOR THE CORRECT INSTALLATION OF THE UPPER RAIL / PRISE DE MESURES POUR UNE INSTALLATION CORRECTE DU TUBE SUPERIEUR / MASSERMITTLUNG ZUR KORREKTEN INSTALLATION DES OBEREN STÜTZROHRES / TOMAR LAS MEDIDAS PARA INSTALAR CORRECTAMENTE EL TUBO SUPERIOR / AFMETINGEN VOOR EEN CORRECTE INSTALLATIE VAN DE BOVENSTE BUIS

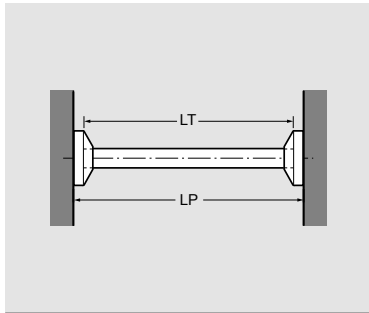

Unione Muro – Muro con articolo 5CS.555.0000 (555-SS)
 Wall/Wall Connection with art. 5CS.555.0000 (555-SS)
 Jonction pari-paroi avec art. 5CS.555.0000 (555-SS)
 Verbindung Wand-Wand mit Artike 5CS.555.0000 (555-SS)
 Unión pared-pared con artículos 5CS.555.0000 (555-SS)
 Verbinding muur-muur met art. 5CS.555.0000 (555-SS)

LP = Distanza tra muro e muro / Distance from wall to wall / Distance pari-paroi
 Abstand zwischen den Wänden / Distancia entre paredes / Afstand tussen de muren
 LT = Lunghezza del tubo da tagliare / Length of the tube to be cut / Longueur du tube à couper / Länge des geschnittenen Rohres / Longitud del tubo a cortar / Lengte van de af te korten buis
 LT = LP - 22 mm

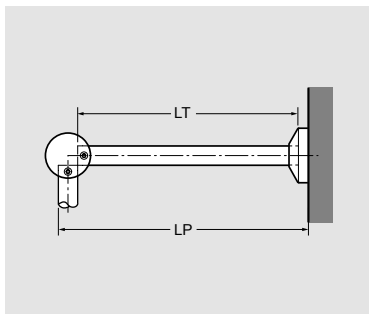

Unione ad angolo tra rosetta e giunto
 Elbow connection with rose and joint
 Jonction d'angle entre la rosace et le raccord
 Eckverbindung zwischen der Rosette und dem Verbindungselement
 Unión con roseta y unión
 Hoekverbinding tussen de rozet en de koppeling

LP = Distanza tra muro ed esterno tubo / Distance from wall to the end of the rail
 Distance entre la paroi et le bout du tube / Abstand zwischen Wand und Aussenrohr
 Distancia entre la pared y la extremidad del tubo / Afstand tussen de muur en het uiteinde van de buis
 LT = Lunghezza del tubo da tagliare / Length of the tube to be cut / Longueur du tube à couper / Länge des geschnittenen Rohres / Longitud del tubo a cortar / Lengte van de af te korten buis
 LT = LP - 32 mm

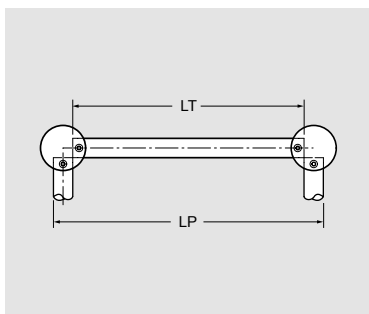

Unione tra giunti
 Elbow connection with joints
 Jonction des raccordes
 Verbindung zwischen den Verbindungselemente
 Conexión con ensamble
 Verbinding tussen de Koppelingen

LP = Distanza tra i due esterno tubo / Distance between the rails / Distance entre les deux bouts du tube / Abstand zwischen den beiden Aussenrohren / Distancia entre las dos extremidades del tubo / Afstand tussen de twee uiteinden van de buis
 LT = Lunghezza del tubo da tagliare / Length of the tube to be cut / Longueur du tube à couper / Länge des geschnittenen Rohres / Longitud del tubo a cortar / Lengte van de af te korten buis
 LT = LP - 44 mm

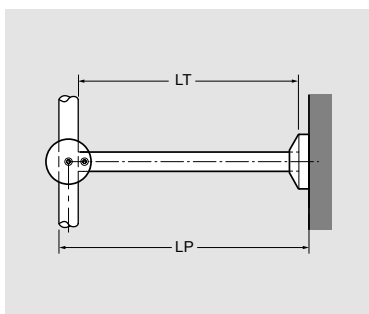

Connessione tra rosetta a muro e giunto a "T"
 Connection wall rose and T-joint
 Jonction entre la rosace sur la paroi et le joint en "T"
 Verbindung zwischen wandrosette und Verbindungselement in t-form
 Unión entre roseta de fijación en pared y unión en "T"
 Verbinding tussen de rozet en de T-koppeling

LP = Distanza tra muro ed esterno tubo / Distance from wall to rail / Distance entre la paroi et le bout du tube / Abstand zwischen der Wand und dem Aussenrohr
 Distancia entre la pared y la extremidad del tubo / Afstand tussen de muur en het uiteinde van de buis
 LT = Lunghezza del tubo da tagliare / Length of the tube to be cut / Longueur du tube à couper / Länge des geschnittenen Rohres / Longitud del tubo a cortar / Lengte van de af te korten buis
 LT = LP - 32 mm

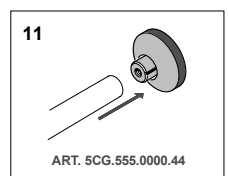
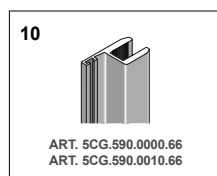
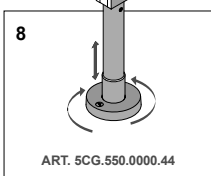
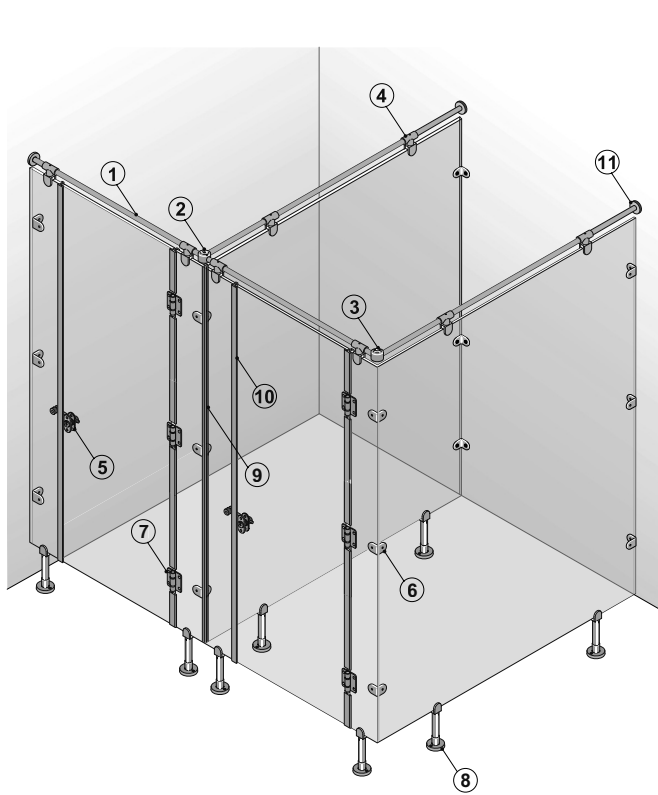
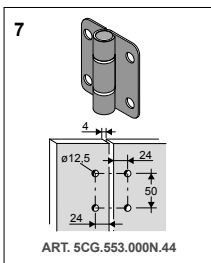
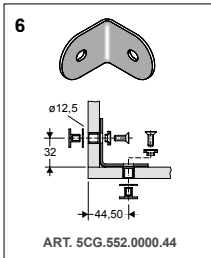
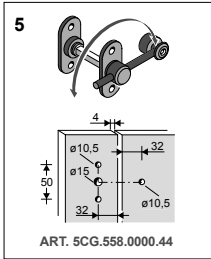
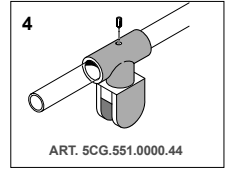
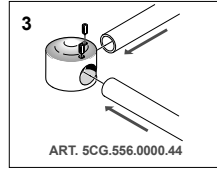
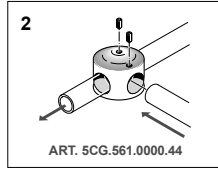
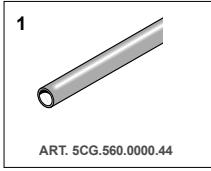

RILIEVO MISURE PER UNA CORRETTA INSTALLAZIONE DEL TUBO SUPERIORE / TAKING MEASUREMENTS FOR THE CORRECT INSTALLATION OF THE UPPER RAIL / PRISE DE MESURES POUR UNE INSTALLATION CORRECTE DU TUBE SUPERIEUR / MASSERMITTLUNG ZUR KORREKTEN INSTALLATION DES OBEREN STÜTZROHRES / TOMAR LAS MEDIDAS PARA INSTALAR CORRECTAMENTE EL TUBO SUPERIOR / AFMETINGEN VOOR EEN CORRECTE INSTALLATIE VAN DE BOVENSTE BUIS

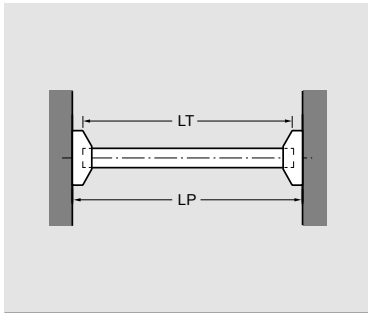

Unione Muro – Muro con articolo 5CG.555.0000 (555-GSS) e 5CG.555.000S (555/S-GSS)
 Wall/Wall Connection with art. 5CG.555.0000 (555-GSS) and 5CG.555.000S (555/S-GSS)
 Jonction pari-paroi avec art. 5CG.555.0000 (555-GSS) et 5CG.555.000S (555/S-GSS)
 Verbindung Wand-Wand mit Article 5CG.555.0000 (555-GSS) und 5CG.555.000S (555/S-GSS)
 Unión pared-pared con artículos 5CG.555.0000 (555-GSS) y 5CG.555.000S (555/S-GSS)
 Verbinding muur-muur met art. 5CG.555.0000 (555-GSS) en 5CG.555.000S (555/S-GSS)

- LP =** Distanza tra muro e muro / Distance from wall to wall / Distance pari-paroi
 Abstand zwischen den Wänden / Distancia entre paredes / Afstand tussen de muren
- LT =** Lunghezza del tubo da tagliare / Length of the tube to be cut / Longueur du tube à couper / Länge des geschnittenen Rohres / Longitud del tubo a cortar / Lengte van de af te korten buis
- LT = LP - 22 mm**

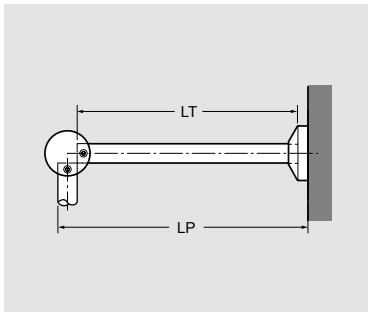

Unione ad angolo tra rosetta e giunto
 Elbow connection with rose and joint
 Jonction d'angle entre la rosace et le raccord
 Eckverbindung zwischen der Rosette und dem Verbindungselement
 Unión con roseta y unión
 Hoekverbinding tussen de rozet en de koppeling

- LP =** Distanza tra muro ed esterno tubo / Distance from wall to the end of the rail
 Distance entre la paroi et le bout du tube / Abstand zwischen Wand und Aussenrohr
 Distancia entre la pared y la extremidad del tubo / Afstand tussen de muur en het uiteinde van de buis
- LT =** Lunghezza del tubo da tagliare / Length of the tube to be cut / Longueur du tube à couper / Länge des geschnittenen Rohres / Longitud del tubo a cortar / Lengte van de af te korten buis
- LT = LP - 36 mm**

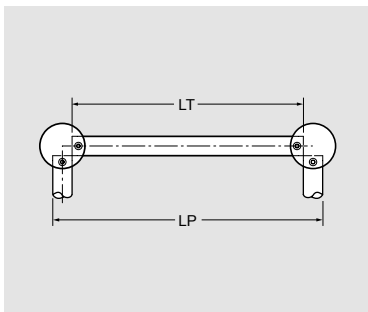

Unione tra giunti
 Elbow connection with joints
 Jonction des raccordes
 Verbindung zwischen den Verbindungselemente
 Conexión con ensamble
 Verbinding tussen de Koppelingen

- LP =** Distanza tra i due esterno tubo / Distance between the rails / Distance entre les deux bouts du tube / Abstand zwischen den beiden Aussenrohren / Distancia entre las dos extremidades del tubo / Afstand tussen de twee uiteinden van de buis
- LT =** Lunghezza del tubo da tagliare / Length of the tube to be cut / Longueur du tube à couper / Länge des geschnittenen Rohres / Longitud del tubo a cortar / Lengte van de af te korten buis
- LT = LP - 52 mm**

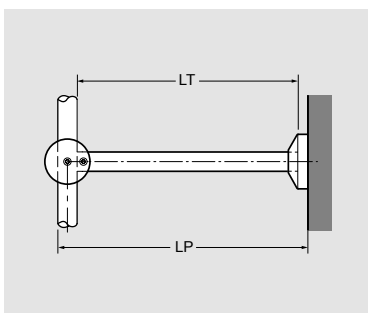

Connessione tra rosetta a muro e giunto a "T"
 Connection wall rose and T-joint
 Jonction entre la rosace sur la paroi et le joint en "T"
 Verbindung zwischen wandrosette und Verbindungselement in T-form
 Unión entre roseta de fijación en pared y unión en "T"
 Verbinding tussen de rozet en de T-koppeling

- LP =** Distanza tra muro ed esterno tubo / Distance from wall to rail / Distance entre la paroi et le bout du tube / Abstand zwischen der Wand und dem Aussenrohr
 Distancia entre la pared y la extremidad del tubo / Afstand tussen de muur en het uiteinde van de buis
- LT =** Lunghezza del tubo da tagliare / Length of the tube to be cut / Longueur du tube à couper / Länge des geschnittenen Rohres / Longitud del tubo a cortar / Lengte van de af te korten buis
- LT = LP - 36 mm**

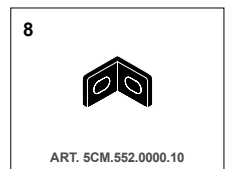
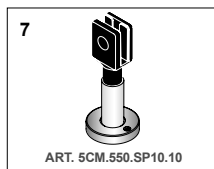
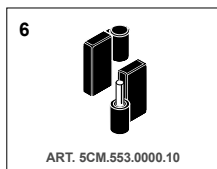
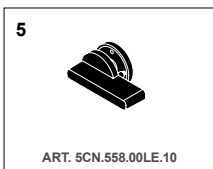
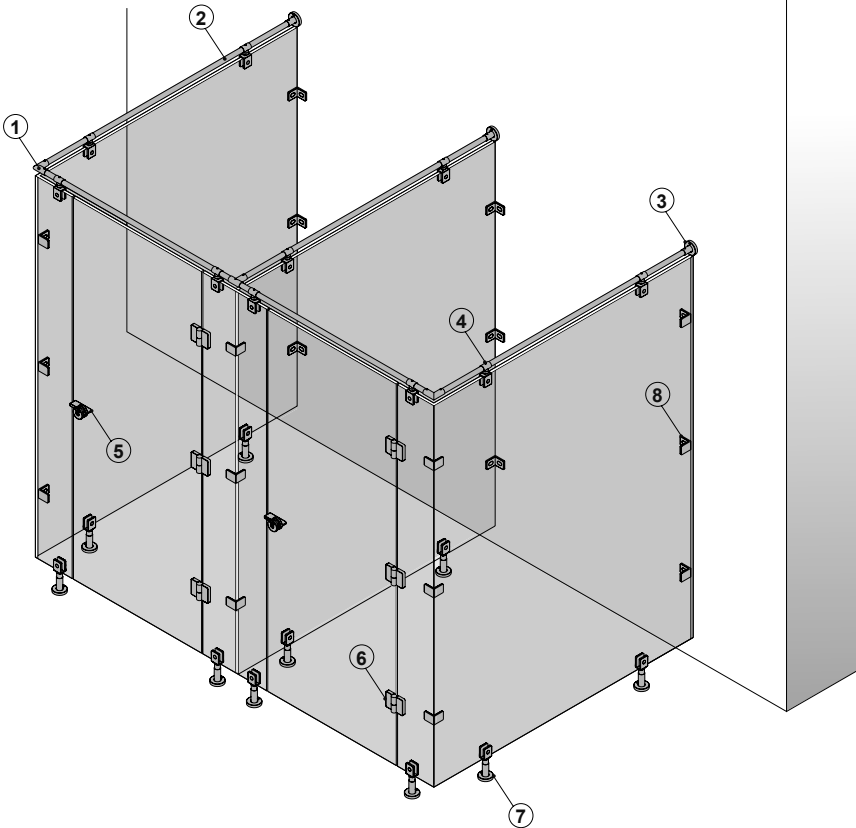
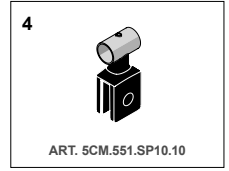
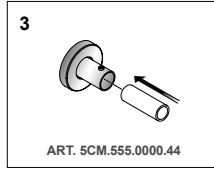
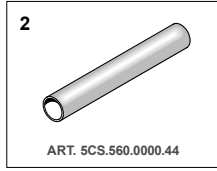
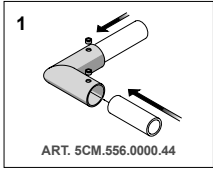

RILIEVO MISURE PER UNA CORRETTA INSTALLAZIONE DEL TUBO SUPERIORE / TAKING MEASUREMENTS FOR THE CORRECT INSTALLATION OF THE UPPER RAIL / PRISE DE MESURES POUR UNE INSTALLATION CORRECTE DU TUBE SUPERIEUR / MASSERMITTLUNG ZUR KORREKTEK INSTALLATION DES OBEREN STÜTZROHRES / TOMAR LAS MEDIDAS PARA INSTALAR CORRECTAMENTE EL TUBO SUPERIOR / AFMETINGEN VOOR EEN CORRECTE INSTALLATIE VAN DE BOVENSTE BUIS

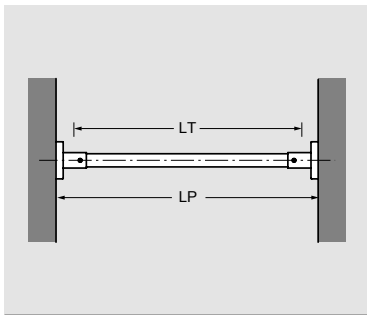

Unione Muro – Muro con articolo 5CM.555.0000
 Wall/Wall Connection with art. 5CM.555.0000
 Jonction pari-paroi avec art. 5CM.555.0000
 Verbindung Wand-Wand mit Artike 5CM.555.0000
 Unión pared-pared con artículos 5CM.555.0000
 Verbinding muur-muur met art. 5CM.555.0000

LP = Distanza tra muro e muro / Distance from wall to wall / Distance pari-paroi
 Abstand zwischen den Wänden / Distancia entre paredes / Afstand tussen de muren
 LT = Lunghezza del tubo da tagliare / Length of the tube to be cut / Longueur du tube à couper / Länge des geschnittenen Rohres / Longitud del tubo a cortar / Lengte van de af te korten buis
 LT = LP - 50 mm

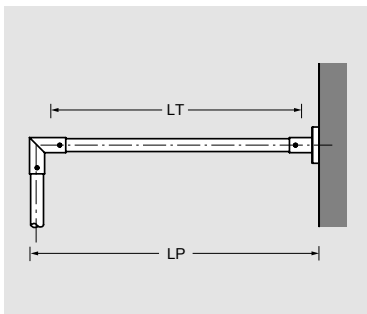

Unione ad angolo tra rosetta e curva
 Elbow connection with rose and bend
 Jonction d'angle entre la rosace et le coude
 Eckverbindung zwischen der Rosette und dem Bogen
 Unión con roseta y codo
 Hoekverbinding tussen de rozet en de bocht

LP = Distanza tra muro ed esterno tubo / Distance from wall to the end of the rail
 Distance entre la paroi et le bout du tube / Abstand zwischen Wand und Aussenrohr
 Distancia entre la pared y la extremidad del tubo / Afstand tussen de muur en het uiteinde van de buis
 LT = Lunghezza del tubo da tagliare / Length of the tube to be cut / Longueur du tube à couper / Länge des geschnittenen Rohres / Longitud del tubo a cortar / Lengte van de af te korten buis
 LT = LP - 59 mm

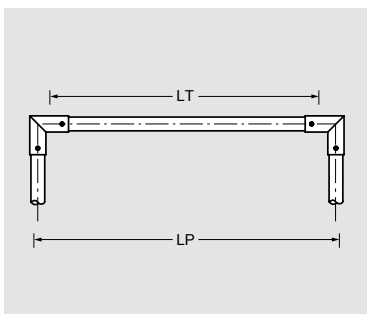

Unione tra curve
 Elbow connection with bends
 Jonction des coudes
 Verbindung zwischen den bögen
 Unión con codos
 Verbinding tussen de bochten

LP = Distanza tra i due esterno tubo / Distance between the rails / Distance entre les deux bouts du tube / Abstand zwischen den beiden Aussenrohren / Distancia entre las dos extremidades del tubo / Afstand tussen de twee uiteinden van de buis
 LT = Lunghezza del tubo da tagliare / Length of the tube to be cut / Longueur du tube à couper / Länge des geschnittenen Rohres / Longitud del tubo a cortar / Lengte van de af te korten buis
 LT = LP - 68 mm

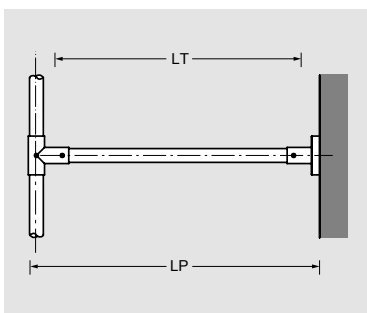

Connessione tra rosetta a muro e giunto a "T"
 Connection wall rose and T-joint
 Jonction entre la rosace sur la paroi et le joint en "T"
 Verbindung zwischen wandrosette und verbindungsselement in t-form
 Unión entre roseta de fijación en pared y unión en "T"
 Verbinding tussen de rozet en de T-koppeling

LP = Distanza tra muro ed esterno tubo / Distance from wall to rail / Distance entre la paroi et le bout du tube / Abstand zwischen der Wand und dem Aussenrohr
 Distancia entre la pared y la extremidad del tubo / Afstand tussen de muur en het uiteinde van de buis
 LT = Lunghezza del tubo da tagliare / Length of the tube to be cut / Longueur du tube à couper / Länge des geschnittenen Rohres / Longitud del tubo a cortar / Lengte van de af te korten buis
 LT = LP - 62 mm

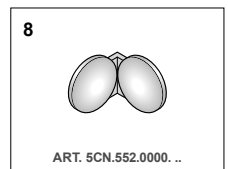
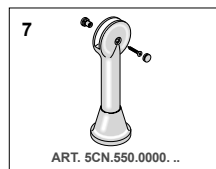
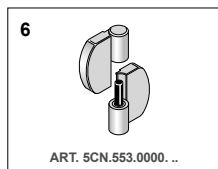
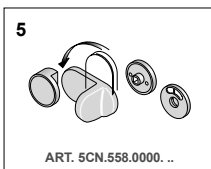
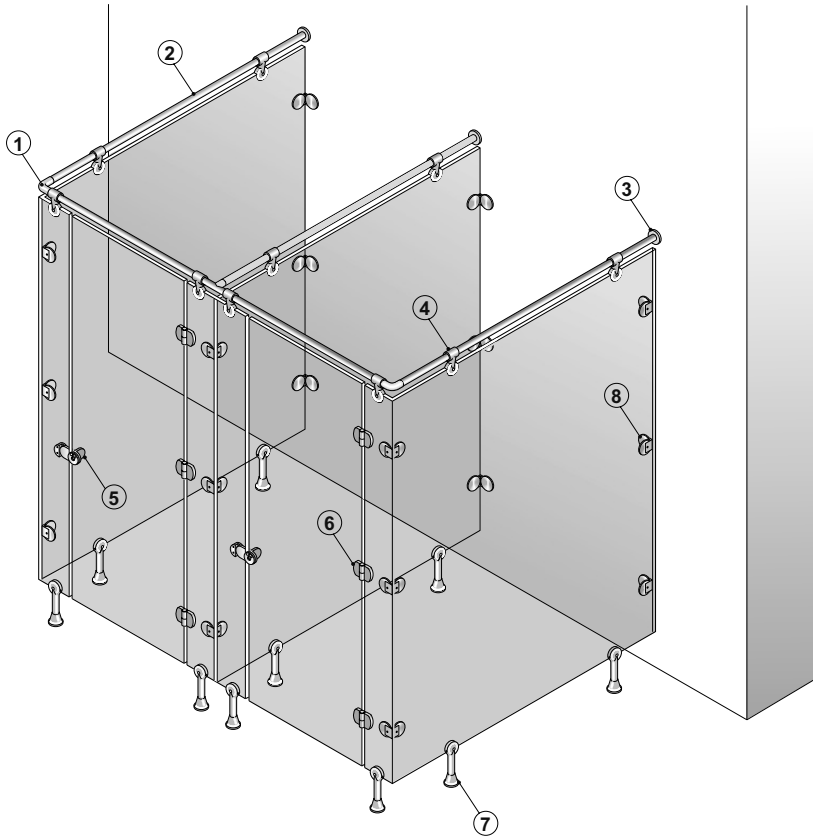
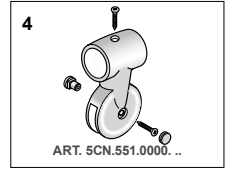
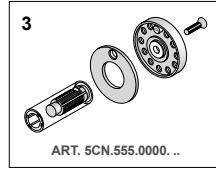
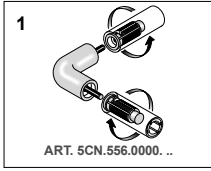

RILIEVO MISURE PER UNA CORRETTA INSTALLAZIONE DEL TUBO SUPERIORE / TAKING MEASUREMENTS FOR THE CORRECT INSTALLATION OF THE UPPER RAIL / PRISE DE MESURES POUR UNE INSTALLATION CORRECTE DU TUBE SUPERIEUR / MASSERMITTLUNG ZUR KORREKTEN INSTALLATION DES OBEREN STÜTZROHRES / TOMAR LAS MEDIDAS PARA INSTALAR CORRECTAMENTE EL TUBO SUPERIOR / AFMETINGEN VOOR EEN CORRECTE INSTALLATIE VAN DE BOVENSTE BUIS

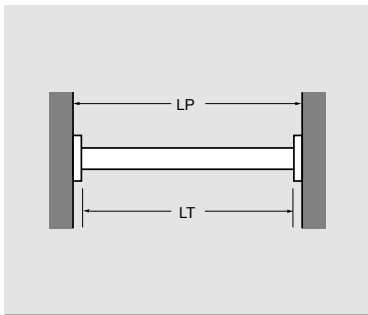

Unione Muro – Muro con articolo 5CN.555.0000 e 5CN.555.000S
 Wall/Wall Connection with art. 5CN.555.0000 and 5CN.555.000S
 Jonction pari-paroi avec art. 5CN.555.0000 et 5CN.555.000S
 Verbindung Wand-Wand mit Article 5CN.555.0000 und 5CN.555.000S
 Unión pared-pared con artículos 5CN.555.0000 y 5CN.555.000S
 Verbinding muur-muur met art. 5CN.555.0000 en 5CN.555.000S

LP = Distanza tra muro e muro / Distance from wall to wall / Distance pari-paroi
 Abstand zwischen den Wänden / Distancia entre paredes / Afstand tussen de muren

LT = Lunghezza del tubo da tagliare / Length of the tube to be cut / Longueur du tube à couper / Länge des geschnittenen Rohres / Longitud del tubo a cortar / Lengte van de af te korten buis

LT = LP - 18 mm

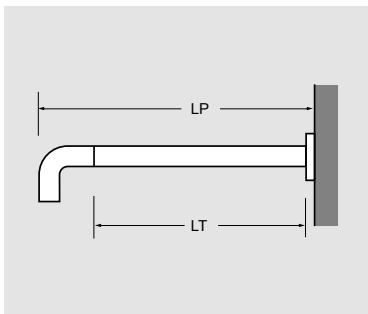

Unione ad angolo tra rosetta e curva
 Elbow connection with rose and bend
 Jonction d'angle entre la rosace et le coude
 Eckverbindung zwischen der Rosette und dem Bogen
 Unión con roseta y codo
 Hoekverbinding tussen de rozet en de bocht

LP = Distanza tra muro ed esterno tubo / Distance from wall to the end of the rail
 Distance entre la paroi et le bout du tube / Abstand zwischen Wand und Aussenrohr
 Distancia entre la pared y la extremidad del tubo / Afstand tussen de muur en het uiteinde van de buis

LT = Lunghezza del tubo da tagliare / Length of the tube to be cut / Longueur du tube à couper / Länge des geschnittenen Rohres / Longitud del tubo a cortar / Lengte van de af te korten buis

LT = LP - 108 mm

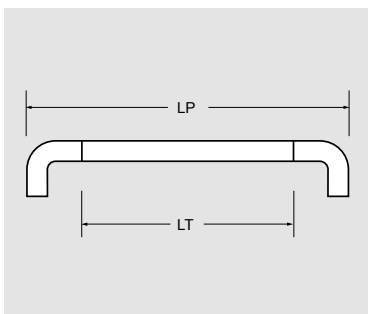

Unione tra curve
 Elbow connection with bends
 Jonction des coudes
 Verbindung zwischen den Bögen
 Unión con codos
 Verbinding tussen de bochten

LP = Distanza tra i due esterno tubo / Distance between the rails / Distance entre les deux bouts du tube / Abstand zwischen den beiden Aussenrohren / Distancia entre las dos extremidades del tubo / Afstand tussen de twee uiteinden van de buis

LT = Lunghezza del tubo da tagliare / Length of the tube to be cut / Longueur du tube à couper / Länge des geschnittenen Rohres / Longitud del tubo a cortar / Lengte van de af te korten buis

LT = LP - 200 mm

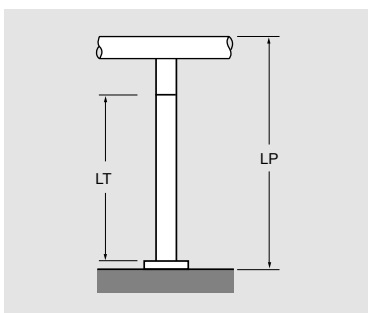

Connessione tra rosetta a muro e giunto a "T"
 Connection wall rose and T-joint
 Jonction entre la rosace sur la paroi et le joint en "T"
 Verbindung zwischen wandrosette und verbindungsselement in t-form
 Unión entre roseta de fijación en pared y unión en "T"
 Verbinding tussen de rozet en de T-koppeling

LP = Distanza tra muro ed esterno tubo / Distance from wall to rail / Distance entre la paroi et le bout du tube / Abstand zwischen der Wand und dem Aussenrohr
 Distancia entre la pared y la extremidad del tubo / Afstand tussen de muur en het uiteinde van de buis

LT = Lunghezza del tubo da tagliare / Length of the tube to be cut / Longueur du tube à couper / Länge des geschnittenen Rohres / Longitud del tubo a cortar / Lengte van de af te korten buis

LT = LP - 108 mm

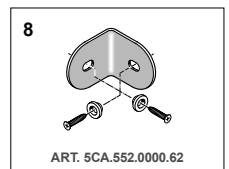
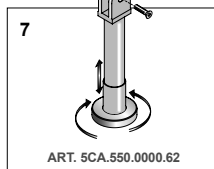
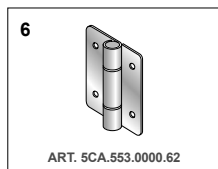
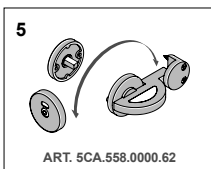
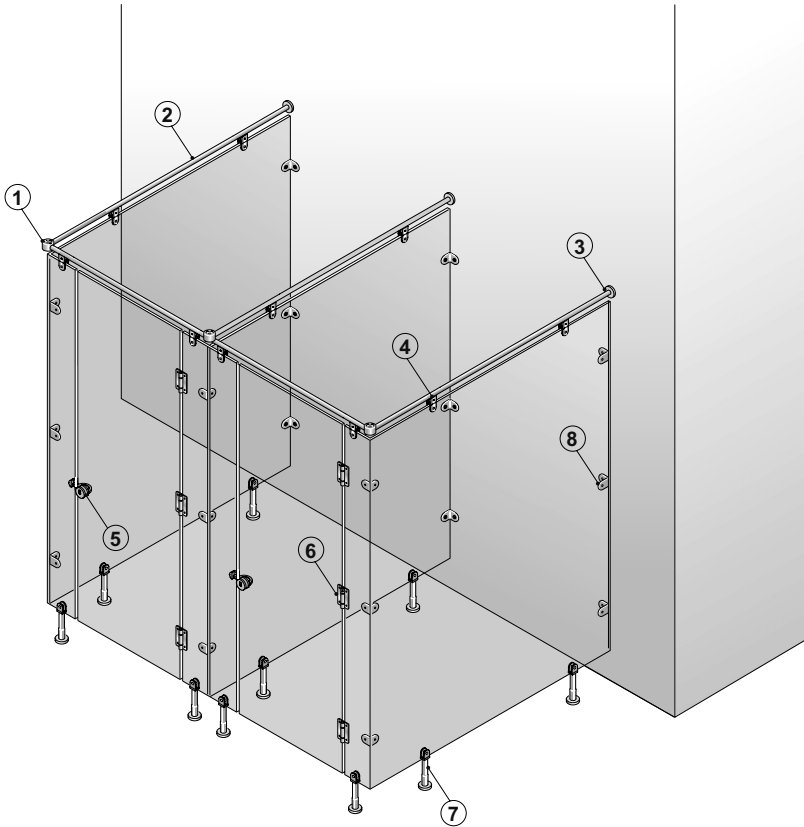
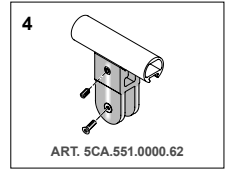
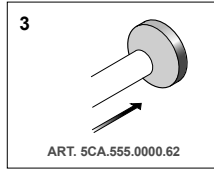
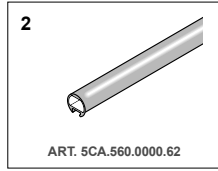
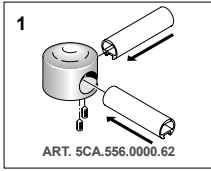

RILIEVO MISURE PER UNA CORRETTA INSTALLAZIONE DEL TUBO SUPERIORE / TAKING MEASUREMENTS FOR THE CORRECT INSTALLATION OF THE UPPER RAIL / PRISE DE MESURES POUR UNE INSTALLATION CORRECTE DU TUBE SUPERIEUR / MASSERMITTLUNG ZUR KORREKTEN INSTALLATION DES OBEREN STÜTZROHRES / TOMAR LAS MEDIDAS PARA INSTALAR CORRECTAMENTE EL TUBO SUPERIOR / AFMETINGEN VOOR EEN CORRECTE INSTALLATIE VAN DE BOVENSTE BUIS

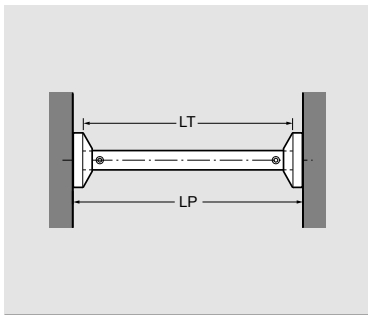

Unione Muro – Muro con articolo 5CA.555.0000
 Wall/Wall Connection with art. 5CA.555.0000
 Jonction paroi-paroi avec art. 5CA.555.0000
 Verbindung Wand-Wand mit Article 5CA.555.0000
 Unión pared-pared con artículos 5CA.555.0000
 Verbinding muur-muur met art. 5CA.555.0000

LP = Distanza tra muro e muro / Distance from wall to wall / Distance paroi-paroi
 Abstand zwischen den Wänden / Distancia entre paredes / Afstand tussen de muren

LT = Lunghezza del tubo da tagliare / Length of the tube to be cut / Longueur du tube à couper / Länge des geschnittenen Rohres / Longitud del tubo a cortar / Lengte van de af te korten buis

LT = LP - 26 mm

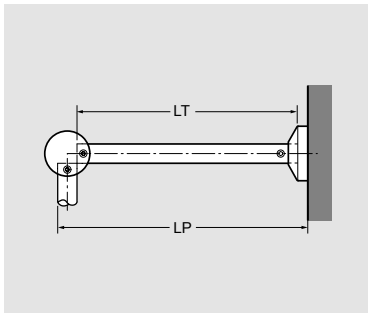

Unione ad angolo tra rosetta e giunto
 Elbow connection with rose and joint
 Jonction d'angle entre la rosace et le raccord
 Eckverbindung zwischen der Rosette und dem Verbindungselement
 Unión con roseta y unión
 Hoekverbinding tussen de rozet en de koppeling

LP = Distanza tra muro ed esterno tubo / Distance from wall to the end of the rail
 Distance entre la paroi et le bout du tube / Abstand zwischen Wand und Aussenrohr
 Distancia entre la pared y la extremidad del tubo / Afstand tussen de muur en het uiteinde van de buis

LT = Lunghezza del tubo da tagliare / Length of the tube to be cut / Longueur du tube à couper / Länge des geschnittenen Rohres / Longitud del tubo a cortar / Lengte van de af te korten buis

LT = LP - 40 mm

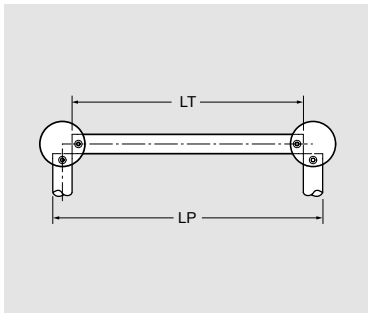

Unione tra giunti
 Elbow connection with joints
 Jonction des raccordes
 Verbindung zwischen den Verbindungselemente
 Conexión con ensamble
 Verbinding tussen de Koppelingen

LP = Distanza tra i due esterno tubo / Distance between the rails / Distance entre les deux bouts du tube / Abstand zwischen den beiden Aussenrohren / Distancia entre las dos extremidades del tubo / Afstand tussen de twee uiteinden van de buis

LT = Lunghezza del tubo da tagliare / Length of the tube to be cut / Longueur du tube à couper / Länge des geschnittenen Rohres / Longitud del tubo a cortar / Lengte van de af te korten buis

LT = LP - 56 mm

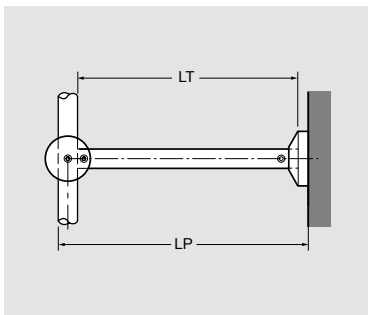

Connessione tra rosetta a muro e giunto a "T"
 Connection wall rose and T-joint
 Jonction entre la rosace sur la paroi et le joint en "T"
 Verbindung zwischen wandrosette und Verbindungselement in t-form
 Unión entre roseta de fijación en pared y unión en "T"
 Verbinding tussen de rozet en de T-koppeling

LP = Distanza tra muro ed esterno tubo / Distance from wall to rail / Distance entre la paroi et le bout du tube / Abstand zwischen der Wand und dem Aussenrohr
 Distancia entre la pared y la extremidad del tubo / Afstand tussen de muur en het uiteinde van de buis

LT = Lunghezza del tubo da tagliare / Length of the tube to be cut / Longueur du tube à couper / Länge des geschnittenen Rohres / Longitud del tubo a cortar / Lengte van de af te korten buis

LT = LP - 40 mm

ARCON

Rosselló, 21. 08029 Barcelona • Tel.: 936 002 002 • info@arcon.es



www.arcon.es