

//DATASHEET

## SALTO GEO Cylinder |

The next generation of electronic cylinder lock:

Fully integrated with the SALTO XS4 platform, SALTO GEO is a versatile, cost effective solution and its compact size and easy installation makes it the ideal electronic locking system for almost any type of door.

## SCANDINAVIAN NORDIC CYLINDER GxS1/2/3

**SALTO**  
inspired**access**



SALTO GEO  
ELECTRONIC CYLINDER  
REMOVABLE KNOB  
SCANDINAVIAN NORDIC PROFILE  
EXTERIOR CYLINDER

The SALTO GEO Scandinavian external cylinder is specially designed to fit most doors that are equipped with a Scandinavian profile cylinder mortise lock. In combination with the G9S2 it can be a double reader (entrance & exit).

SALTO GEO SACANDINAVIAN PROFILE MODEL: EXTERIOR

SCANDINAVIAN NORDIC CYLINDER GxS1

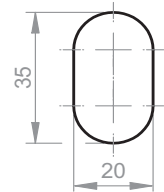
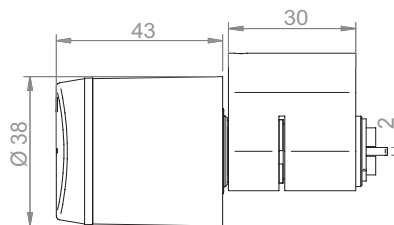

MAIN FEATURES:

- Fully integrated with the SALTO XS4 platform.
- Virtual network capable through SALTO Virtual Network technology.
- Choice of ID carriers: i-Button, HID iClass®, LEGIC Advant, Mifare, DESFire, Mifare Ultralight C.
- NFC compatible on contactless versions.
- All communications between the carrier and the SALTO GEO cylinder are encrypted and secure.
- Optical signalling through light ring. Dual colour green/red to indicate access authorisation. Acoustic signal optional.
- Available in 6 different finishes: satin chrome, polished chrome, polished brass, satin brass, black satin chromium and BioCote®.
- High security via high resistance, hardened anti-drill protection.
- Concealed fixing screws for greater security and improved aesthetics.
- Optional, torx screw to tighten the knob and convert the cylinder on a fix knob cylinder.
- Emergency opening by means of portable programming device (PPD).
- IP protection: model IP55 and model IP66 for outside use.
- In combination with the G9S2 it can be a double reader.

SALTO GEO  
ELECTRONIC CYLINDER  
REMOVABLE KNOB  
SCANDINAVIAN NORDIC PROFILE  
INTERNAL CYLINDER

The SALTO GEO Scandinavian internal cylinder is specially designed to fit most doors that are equipped with a Scandinavian profile cylinder mortise lock. In combination with the G9S1 it can be a double reader (entrance & exit).

SALTO GEO SACANDINAVIAN PROFILE MODEL: INTERIOR

SCANDINAVIAN NORDIC CYLINDER GxS2

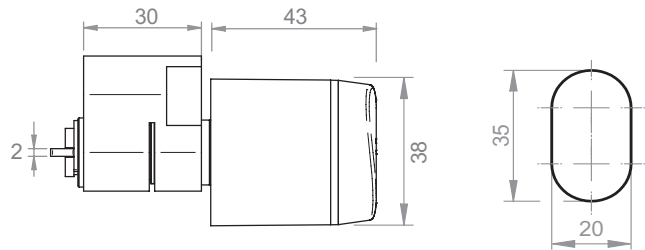

MAIN FEATURES:

- Fully integrated with the SALTO XS4 platform.
- Virtual network capable through SALTO Virtual Network technology.
- Choice of ID carriers: i-Button, HID iClass®, LEGIC Advant, Mifare, DESFire, Mifare Ultralight C.
- NFC compatible on contactless versions.
- All communications between the carrier and the SALTO GEO cylinder are encrypted and secure.
- Optical signalling through light ring. Dual colour green/red to indicate access authorisation. Acoustic signal optional.
- Available in 6 different finishes: satin chrome, polished chrome, polished brass, satin brass, black satin chromiun and BioCote®.
- High security via high resistance, hardened anti-drill protection.
- Concealed fixing screws for greater security and improved aesthetics.
- Optional, torx screw to tighten the knob and convert the cylinder on a fix knob cylinder.
- Emergency opening by means of portable programming device (PPD).
- IP protection: model IP55 and model IP66 for outside use.
- In combination with the G9S1 it can be a double reader.

## SALTO GEO ELECTRONIC CYLINDER REMOVABLE KNOB SCANDINAVIAN NORDIC PROFILE SECURITY CYLINDER

The SALTO GEO Scandinavian external cylinder is specially designed to fit most doors that are equipped with a Scandinavian Security external profile cylinder mortise lock.

### SALTO GEO SACANDINAVIAN PROFILE MODEL: SECURITY

#### SCANDINAVIAN NORDIC CYLINDER GxS3

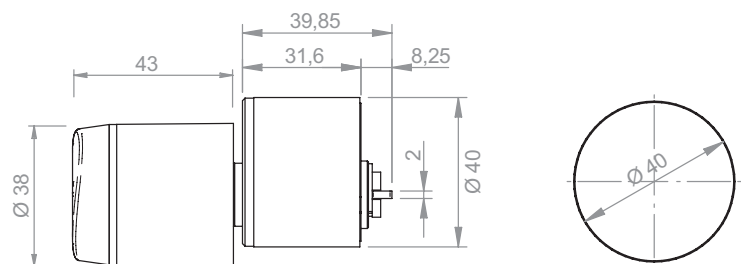

#### MAIN FEATURES:

- Fully integrated with the SALTO XS4 platform.
- Virtual network capable through SALTO Virtual Network technology.
- Choice of ID carriers: i-Button, HID iClass®, LEGIC Advant, Mifare, DESFire, Mifare Ultralight C.
- NFC compatible on contactless versions.
- All communications between the carrier and the SALTO GEO cylinder are encrypted and secure.
- Optical signalling through light ring. Dual colour green/red to indicate access authorisation. Acoustic signal optional.
- Available in 6 different finishes: satin chrome, polished chrome, polished brass, satin brass, black satin chromium and BioCote®.
- High security via high resistance, hardened anti-drill protection.
- Concealed fixing screws for greater security and improved aesthetics.
- Optional, torx screw to tighten the knob and convert the cylinder on a fix knob cylinder.
- Emergency opening by means of portable programming device (PPD).
- IP protection: model IP55 and model IP66 for outside use.

## ELECTRONIC MAIN FEATURES AND BENEFITS:

- Simple offline installation is possible for any type of door, including those with narrow frames.
- Virtual network capable through SALTO Virtual Network technology.
- Audit trail capability via the SALTO Virtual Network (SVN). Contactless versions compatible with ISO 14.443A, ISO 15693, ISO 14.443B and covering a wide range of mainstream RFID brands such as DESfire, DESfire EV1, Mifare, Mifare plus, Ultralight C, allowing multiapplication with third party systems using one card.
- SALTO GEO Electronic cylinder contactless range is compatible with NFC (Near Field Communication) technology which allows NFC enabled cell phones to act as contactless data carriers to open and control SALTO access controlled doors.
- All communications between the carrier and the electronic cylinder are encrypted and secured.
- Choice of different cam and cylinder profiles.
- Different finishes: BioCote®, Satin chrome, polished chrome, polished brass, satin brass.
- High security via high resistance, hardened anti-drill protection.
- Concealed fixing screws for greater security and improved aesthetics.
- Low battery power indication monitored through the SALTO Virtual Network (SVN) as low battery status information is written onto carriers and passed to the software. Also readings can be taken at the lock and passed to the software via PPD connection.
- Dual colour LED (green / red) to indicate access authorisation.
- Emergency opening by means of portable programming device (PPD).
- Firmware upgradable through PPD.

## REMOVABLE KNOB:

### REMOVABLE KNOB

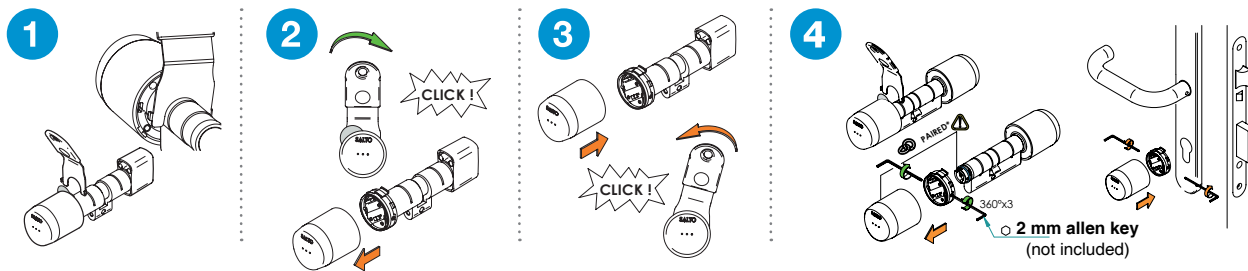

### BATTERY CHANGE

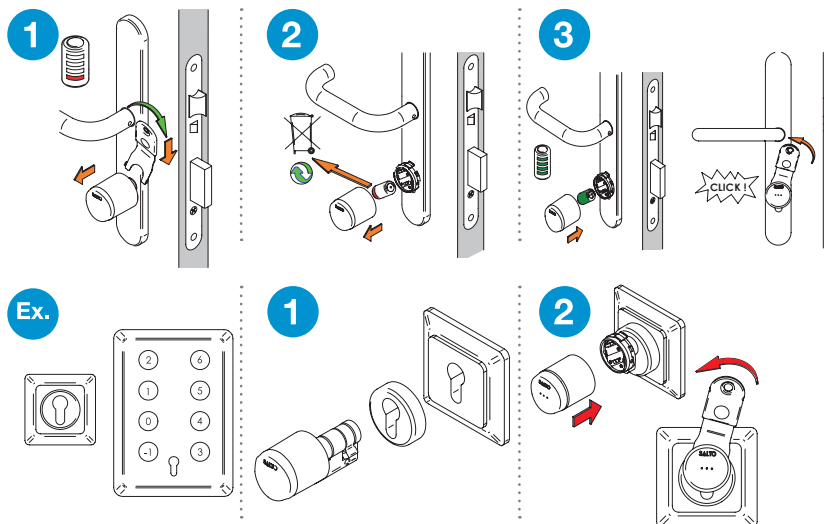

## AVAILABLE LOCK MODES:

- **STANDARD**: locked at all times.
- **AUTOMATIC OPENING**: 8 pairs of "hands free" timed lock and unlocks per day with holidays.
- **TOGGLE**: present card to lock, present card to unlock.
- **TIME TOGGLE**: present card to lock, present card to unlock depending on schedules.

FINISHES:



Satin  
Stainless Steel  
**CSB**



Polished  
Stainless Steel  
**CPB**



Satin  
Brass  
**PMB**

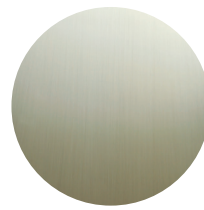

Polished  
Brass  
**PPB**

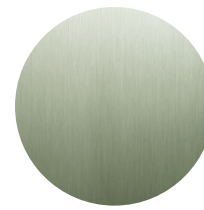

BioCote®  
Antimicrobial  
**BCB**

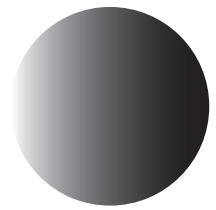

Black Satin  
Chromium  
**NEB**

ACCESS CONTROL FEATURES:

	SELFPROGRAMMABLE	ROM	R&W SVN	Wireless System
Maximum number of users per door	1000	1000	4,000,000	4,000,000
Maximum number of doors per system	-	16,000	64,000	64,000
Maximum events on lock audit	-	650	1000	1000
Timezones	-	30	256	256
Timeperiods	-	20	256	256
Calendars in system	-	42	56	256
User groups	-	unlimited	unlimited	unlimited
Zones in System	-	unlimited	unlimited	unlimited
Management software	Programing key & user key sets	ProAccess ROM	ProAccess HAMS (available SQL)	ProAccess HAMS (available SQL)

ID TECHNOLOGIES:

- **MIFARE:** Mifare, Mifare plus, Ultralight C, DESfire, DESfire EV1 and Vicinity cards.
- **LEGIC:** Legic Advant.
- **HID:** HID iClass®
- **i-BUTTON:** ROM - RW
- **NFC:** SALTO GEO Electronic cylinder contactless range is compatible with NFC (Near Field Communication) technology which allows NFC enabled cell phones to act as contactless data carriers to open and control SALTO access controlled doors.

RANGE OF RFID CREDENTIAL / KEYS AVAILABLE:



Contactless RFID Key  
Cards



Contactless RFID  
Fobs



Contactless RFID  
Silicone Bracelet



Contactless RFID  
Fobs Bracelet



i-Button Key



i-Button Key Bracelet

## MIFARE:

Mifare RFID contactless technology reads & writes information to contactless smart cards (RFID) compatible with ISO 14.443A, ISO 14.443B and ISO 15.693 standards, and as Mifare, Mifare plus, DESFire, DESFireEV1 technologies. They also allow for updating of the carriers via SALTO Virtual Net (SVN) technology.

- Fully integrated with the SALTO XS4 platform.
- 13.56MHz contactless RFID identification.
- ISO 14.443A, ISO 14.443B and ISO 15.693, Mifare, DESFire Compatible.
- Near Field Communication (NFC) compatible.
- Key card available: 1Kbyte, 4Kbytes and 8 Kbytes depending on technology.
- Key shape available: ISO 7810 Cards, fobs, bracelets, stickers, watches...
- Reusable key cards.
- SALTO Virtual Network (SVN) compatible\*.
- RFID technology permits contactless exchange of information between the card and the reader\*.
- High security encrypted Proximity cards.
- Multiapplication with other systems using the same card with different sectors.
- Customized issuing card through the SALTO Authorization Media software (SAM).
- Waterproof cards which can be customized.
- Upgradable: selfprogrammable, ROM, R&W systems available using the same hardware.

## LEGIC Advant:

LEGIC Ident systems includes highly integrated LEGIC RF Standard and ISO 15693 and ISO 14443 compliant read/write Chip Sets, Security Modules and Transponder Chips for integration into third party products. A very good option if you already use a Legic transponder system.

- 13.56MHz contact less RFID identification.
- Key card available: 2 kbytes.
- Key shape available: ISO 15693, ISO 14443 and LEGIC RF Cards.
- Reusable key cards.
- SALTO Virtual Network (SVN) compatible.
- Read & Write technology permits contactless exchange of information between the card and the reader.
- High security, by using password and encrypted 3DES, DES and Legic encryption.
- Multiapplication with other systems using the same card with different segments..
- Customized issuing card memory through the Legic protocol.
- Waterproof cards which can be customized.

## HID iCLASS®:

HID iCLASS® contactless technology from HID is R&W identification technology based on 13.56 MHz read/write contactless smart card technology. HID iCLASS® offers enhanced security through encryption. This single-card, contactless solution permits multiapplication with others systems, and with the SVN capabilities, you will acquire a lot of interesting new features for your property access control.

- 13.56MHz contact less RFID identification.
- ISO 14.443B2 standard compliant. ISO 15.693 standard compliant.
- Reusable key cards.
- SALTO Virtual Network (SVN) compatible.
- Read & Write technology permits contactless exchange of information between the card and the reader.
- High security, by using password and encrypted Proximity cards.
- Multiapplication with other systems using the same card through shared pages.
- Customized issuing card through the SALTO Authorization Media software (SAM).
- Waterproof cards which can be customized.
- Upgradable: ROM, R&W systems available using the same hardware.

## i-BUTTON:

The i-Button technology is a robust and ergonomic technology due to the design of the fob and the lock. The SALTO GEO i-Button electronic cylinders need no hard wiring and provide a modern solution to the problem of lost keys or masterkeys. Compatible with data on card technology SALTO Virtual Network (SVN) system that allows you to control all the doors in an entire building or group of buildings from a single PC.

- Access given through contact by electronic i-Button.
- Simple and intuitive use due to the smart design of the i-Button and the electronic lock reader.
- Extremely resistant system, suitable for all kind of environments.
- 512bytes or 2Kbytes i-Button fobs or bracelets available.
- Reusable keys
- SALTO Virtual Network (SVN) compatible.
- Different sort of i-Button fobs or bracelets available.
- High security, by using password and encrypted i-Button fobs.
- i-Buttons can be customized by numeration.
- i-Buttons are waterproof.
- Compatible with SMILE technology and/ or ROM system that allows you to control all the doors. No software or computer is required

## OPTIONAL ACCESSORIES / GRIPS:

SALTO GEO cylinder grips have been designed to improve the operation of SALTO GEO electronic cylinders. Suitable for use with gloves or by the disabled, the new SALTO Cylinders Grips provide an additional surface making the knob easier to operate.

- Disability Discrimination Act (DDA) compliant.
- BioCote® antimicrobial protection, silver ion technology.
- SALTO GEO Cylinders Grip H and A models are available in:
  - Red,
  - Blue,
  - Yellow,
  - Green,
  - White
  - Black.



GRIP H



GRIP A (DDA)

## TECHNICAL DATA:

### CURRENT REQUIRED:

- 1 Lithium standard battery CR2.
- Number of openings:
  - i-Button version: Up to 60,000 on 1 battery.
  - Contactless versions: Up to 40.000 on 1 battery, depending on the RFID technology.

### ENVIRONMENTAL CONDITIONS:

- -20° / 60°.

### CERTIFICATIONS:

- Declaration of Comity CE
- Use of radio frequency spectrum**
  - ETSI EN 302 291-1 V1.1.1 (2005-07)
  - ETSI EN 302 291-2 V1.1.1 (2005-07)
- Electromagnetic Compatibility**
  - ETSI EN 301 489-1 (2011-09)
  - ETSI EN 301 489-3 (2002-08)
- Security requirements**
  - EN 60950-1 (2007)
  - Following the provisions of the directive

### IP CERTIFICATIONS: Outdoor Protection Standard

- IP55\* MODEL (SALTO GEO standard model)

SOLID PARTICLE RESISTANT	LIQUID INGRESS RESISTANT
Quantity of dust ingress is not sufficient to interfere normal operation.	Water projected by a nozzle (6.3mm) against enclosure from any direction at least 3 minutes, 12.5 litres per minute, 30 kN/m <sup>2</sup> at distance of 3m, shall have no harmful effects.

- IP66\* MODEL (SALTO GEO water resistant model [GxxxxxR])

SOLID PARTICLE RESISTANT	LIQUID INGRESS RESISTANT
No ingress of dust.	Water projected in powerful jets (12.5mm nozzle) against the enclosure from any direction at least 3 minutes, 100 litres per minute, 100 kN/m <sup>2</sup> at distance of 3m, shall have no harmful effects.

\* IP66 refers only to electronic knob. Water entrance through the cam is not protected.

## SALTO ACCESS CONTROL PLATFORM FEATURES:

The SALTO range of electronic cylinders is fully integrated with the XS4 platform and their versatile, compact size makes them an ideal solution for almost any type of door where fitting a conventional electronic handle set is not possible or required.

The XS4 thumb turn SALTO GEO models offer virtual network capability thanks to their SALTO Virtual Network (SVN) technology as well as a choice of ID carriers.

Whatever your access control needs, SALTO electronic cylinders provide an ultra modern solution that will compliment any type of door wherever they are used.

- Completely integrated in the SALTO Systems platform.
- Enables users to have stand-alone electronic cylinders, stand-alone electronic locks, stand-alone electronic glass door locks (SALTO wireless compatible), emergency exit devices (SALTO wireless compatible), locker locks and IP based online readers, all in the same system with SALTO Virtual Network capabilities, making it possible to update user card access plans quickly and easily.

## SALTO GEO ELECTRONIC CYLINDERS FEUTURES:



SALTO Systems reserves the right to modify technical specifications, designs and performance without notice. © SALTO SYSTEMS 2014